

**NORME
INTERNATIONALE**

**CEI
IEC**

**INTERNATIONAL
STANDARD**

60601-1-2

Second edition
200X-YY

Medical electrical equipment

Part 1:

General requirements for safety

2. Collateral Standard: Electromagnetic
compatibility - Requirements and tests

CONTENTS

	Page
FOREWORD.....	6
INTRODUCTION.....	9

SECTION 1: GENERAL

Clause	
1	Scope and object.....
1.201	Scope.....
1.202	Object.....
2	Terminology and definitions.....
2.201	COMPLIANCE LEVEL.....
2.202	CRITICAL FUNCTION
2.203	DEGRADATION
2.204	EFFECTIVE RADIATED POWER
2.205	ELECTROMAGNETIC COMPATIBILITY
2.206	ELECTROMAGNETIC DISTURBANCE
2.207	ELECTROMAGNETIC EMISSION
2.208	ELECTROMAGNETIC ENVIRONMENT
2.209	ELECTROMAGNETIC NOISE.....
2.210	EXCLUSION BAND.....
2.211	FUNCTION.....
2.212	IEC 60601-1-2 TEST LEVEL.....
2.213	IMMUNITY
2.214	IMMUNITY LEVEL
2.215	IMMUNITY TEST LEVEL
2.216	INFORMATION TECHNOLOGY EQUIPMENT.....
2.217	LARGE EQUIPMENT and/or SYSTEM
2.218	LIFE-SUPPORTING EQUIPMENT and/or SYSTEM
2.219	LOW VOLTAGE.....
2.220	MEDICAL ELECTRICAL SYSTEM
2.221	OPERATING FREQUENCY
2.222	PATIENT-COUPLED EQUIPMENT and/or SYSTEM.....

2.223 PHYSIOLOGICAL SIMULATION FREQUENCY

2.224 PUBLIC MAINS NETWORK

2.225 RADIO FREQUENCY

3 General requirements.....

3.201 General requirements for ELECTROMAGNETIC COMPATIBILITY of
EQUIPMENT and/or SYSTEMS

3.201.1 ELECTROMAGNETIC COMPATIBILITY

3.201.2 CRITICAL FUNCTIONS

3.201.3 MEDICAL ELECTRICAL EQUIPMENT.....

3.201.4 Non-medical equipment.....

6 IDENTIFICATION, marking and documents

6.1.201 Markings on the outside of EQUIPMENT or EQUIPMENT parts

6.1.201.1 Markings on the outside of EQUIPMENT or EQUIPMENT parts that
include RF transmitters and/or that apply RF electromagnetic
energy for diagnosis and/or treatment.....
.....

6.1.201.2 Markings on the outside of EQUIPMENT or EQUIPMENT parts for
which the connector testing exemption specified in Subclause
36.202.2 b) 3 is used

6.1.201.3 Markings on the outside of EQUIPMENT and/or SYSTEMS that are
specified for use only in a shielded location.....

6.8.201 ACCOMPANYING DOCUMENTS.....

6.8.201.1 General

6.8.201.2 Instructions for use

SECTIONS 2 to 4: Not Used

SECTION 5: PROTECTION AGAINST HAZARDS FROM
UNWANTED OR EXCESSIVE RADIATION

36 ELECTROMAGNETIC COMPATIBILITY

36.201 EMISSIONS.....

36.201.1 Protection of radio services.....

36.201.2 Protection of other equipment.....

36.201.2.1 Low frequency magnetic fields.....

36.201.3	Protection of the PUBLIC MAINS NETWORK.....
36.201.3.1	Harmonic distortion
36.201.3.2	Voltage fluctuations and flicker.....
36.202	IMMUNITY.....
36.202.1	General
36.202.2	Electrostatic discharge (ESD)
36.202.3	Radiated RF electromagnetic fields.....
36.202.4	Electrical fast transients and bursts
36.202.5	Surges.....
36.202.7	Voltage dips, short interruptions and voltage variations on power supply input lines.....
36.202.6	Conducted disturbances, induced by RF fields.....
36.202.8	Magnetic fields.....
36.202.8.1	Power frequency magnetic fields.....
36.202.8.2	Pulsed magnetic fields.....
36.202.8.3	Damped oscillatory magnetic fields
36.202.9	Conducted disturbances in the range 0 Hz to 150 kHz
36.202.10	Oscillatory waves
36.202.11	Harmonics, interharmonics including mains signalling at a.c. power port.....
36.202.12	Ripple on d.c. power supply.....
36.202.13	Unbalance.....
36.202.14	Variations of power frequency.....

SECTIONS 6 to 10: Not Used

TABLES

201	ELECTROMAGNETIC EMISSIONS Guidance and manufacturer's declaration - for all EQUIPMENT and/or SYSTEMS.....
202	Electromagnetic IMMUNITY Guidance and manufacturer's declaration - for all EQUIPMENT and/or SYSTEMS.....
203a	Electromagnetic IMMUNITY Guidance and manufacturer's declaration – for LIFE-SUPPORTING EQUIPMENT and/or SYSTEMS.
203b	Electromagnetic IMMUNITY Guidance and manufacturer's declaration – for EQUIPMENT and/or SYSTEMS that are not LIFE-SUPPORTING

204a	Recommended Separation Distances for Portable and Mobile RF Communications Equipment – for LIFE-SUPPORTING EQUIPMENT and/or SYSTEMS.....
204b	Recommended Separation Distances for Portable and Mobile RF Communications Equipment – for EQUIPMENT and/or SYSTEMS that are not LIFE-SUPPORTING
205a	Electromagnetic IMMUNITY Guidance and manufacturer’s declaration – for LIFE-SUPPORTING EQUIPMENT and/or SYSTEMS that are specified for use only in a shielded location.....
205b	Electromagnetic IMMUNITY Guidance and manufacturer’s declaration – for EQUIPMENT and/or SYSTEMS that are not LIFE-SUPPORTING and are specified for use only in a shielded location
206	Modulation Frequency, PHYSIOLOGICAL SIMULATION FREQUENCY, and OPERATING FREQUENCY.....
207	IMMUNITY TEST LEVELS for voltage dips.....
208	IMMUNITY TEST LEVEL for voltage interruption.....

FIGURES

201a	Instructions for completing Table 201 – for CISPR 11 EQUIPMENT and/or SYSTEMS
201b	Instructions for completing Table 201 – for CISPR 14 and CISPR 15 EQUIPMENT.....
202	Instructions for completing Table 202.....
203a	Instructions for completing Tables 203a and 204a – for LIFE-SUPPORTING EQUIPMENT and/or SYSTEMS.....
203b	Instructions for completing Tables 203b and 204b – for EQUIPMENT and/or SYSTEMS that are not LIFE-SUPPORTING
AAA201	Example of cable arrangement for radiated IMMUNITY test
AAA202	Examples showing maximum dimension for an EQUIPMENT with one and with two cables.....

ANNEXES

AAA	General guidance and rationale
BBB	Example completion of Tables 201, 202, 203a, 203b, 204a, 204b and 205a.....
CCC	Guidance in classification to CISPR 11

DDD	Guidance in the application of IEC 60601-1-2 to Particular Standards
EEE	ELECTROMAGNETIC ENVIRONMENTS
FFF	Normative references
GGG	Bibliography

INTERNATIONAL ELECTROTECHNICAL COMMISSION

MEDICAL ELECTRICAL EQUIPMENT**Part 1: General requirements for safety****2. Collateral Standard:****Electromagnetic compatibility — Requirements and tests**

FOREWORD

- 1) The IEC (International Electrotechnical Commission) is a world-wide organization for standardization comprising all national electrotechnical committees (IEC National Committees). The object of the IEC is to promote international cooperation on all questions concerning standardization in the electrical and electronic fields. To this end and in addition to other activities, the IEC publishes International Standards. Their preparation is entrusted to technical committees; any IEC National Committee interested in the subject dealt with may participate in this preparatory work. International, governmental and non-governmental organizations liaising with the IEC also participate in this preparation. The IEC collaborates closely with the International Organization for Standardization (ISO) in accordance with conditions determined by agreement between the two organizations.
- 2) The formal decisions or agreements of the IEC on technical matters, prepared by technical committees on which all the National Committees having a special interest therein are represented, express, as nearly as possible, an international consensus of opinion on the subjects dealt with.
- 3) They have the form of recommendations for international use published in the form of standards, technical reports or guides and they are accepted by the National Committees in that sense.
- 4) In order to promote international unification, IEC National Committees undertake to apply IEC International Standards transparently to the maximum extent possible in their national and regional standards. Any divergence between the IEC Standard and the corresponding national or regional standard shall be clearly indicated in the latter.
- 5) The IEC provides no marking procedure to indicate its approval and cannot be rendered responsible for any equipment declared to be in conformity with one of its standards.

International Standard IEC 60601-1-2 has been prepared by IEC sub-committee 62A: Common aspects of electrical equipment used in medical practice, of IEC technical committee 62: Electrical equipment in medical practice. It constitutes a Collateral Standard to IEC 60601-1: Medical electrical equipment — Part 1: General requirements for safety, hereinafter referred to as the General Standard.

In the 60601 series of publications, Collateral Standards specify general requirements for safety applicable to:

- a group of MEDICAL ELECTRICAL EQUIPMENT (e.g. radiological equipment);
- a specific characteristic of all MEDICAL ELECTRICAL EQUIPMENT, not fully addressed in the General Standard (e.g. ELECTROMAGNETIC COMPATIBILITY).

In addition, IEC 60601-1-1 has expanded the scope of the general standard to include MEDICAL ELECTRICAL SYSTEMS. In recognition of that expanded scope, this edition of the EMC Collateral Standard takes into account the fact that the general standard now applies to MEDICAL ELECTRICAL SYSTEMS as well as MEDICAL ELECTRICAL EQUIPMENT and includes EMC requirements that are, in most cases, applicable to all parts of the SYSTEM.

The text of this standard is based on the following documents:

FDIS	Report on Voting

Full information on the voting for the approval of this standard can be found in the report on voting indicated in the above table.

The numbering of sections, clauses and subclauses of this Collateral Standard corresponds with that of the General Standard.

Subclauses and figures that are additional to those of the General Standard are numbered starting from 201; additional annexes are lettered AAA, BBB, etc., and additional items aaa), bbb), etc.

In this Collateral Standard, the following print types are used:

- requirements, compliance with which can be tested and definitions: in roman type;
- explanations, advice, general statements, exceptions and references: in smaller type;
- *test specifications: in italic type;*
- TERMS DEFINED IN CLAUSE 2 OF THE GENERAL STANDARD OR OF THIS COLLATERAL STANDARD: SMALL CAPITALS.

The requirements are followed by specifications for the relevant tests.

Some provisions or statements in the body of this Collateral Standard require additional information. Such information is presented in the informative annex AAA,

General guidance and rationale. An asterisk (*) in the left margin of a clause or subclause indicates the presence of additional information in Annex AAA.

Annexes AAA, BBB, CCC, DDD, EEE and GGG are informative whereas Annex FFF, is normative.

INTRODUCTION

The need for establishing specific ELECTROMAGNETIC COMPATIBILITY standards for MEDICAL ELECTRICAL EQUIPMENT and MEDICAL ELECTRICAL SYSTEMS (both referred to as EQUIPMENT and/or SYSTEMS in this Collateral Standard) is well recognized.

In particular, the existence of ELECTROMAGNETIC EMISSION standards is essential for the protection of:

- safety services;
- other EQUIPMENT and/or SYSTEMS;
- non-medical equipment (e.g. computers);
- telecommunications (e.g. radio/TV, telephone, radio-navigation).

Of even more importance, the existence of ELECTROMAGNETIC IMMUNITY standards is essential to assure safety of EQUIPMENT and/or SYSTEMS. ELECTROMAGNETIC COMPATIBILITY (see definition 2.205) differs from other aspects of safety covered by IEC 60601-1 because the electromagnetic phenomena exist, with varying degrees of severity, in the normal use environment of all EQUIPMENT and/or SYSTEMS and by definition the equipment must “perform satisfactorily” within its intended environment in order to establish ELECTROMAGNETIC COMPATIBILITY. This means that the conventional single fault approach to safety is not appropriate for application to ELECTROMAGNETIC COMPATIBILITY standards. The ELECTROMAGNETIC DISTURBANCE environment can be compared to ambient temperature, humidity and atmospheric pressure. EQUIPMENT and/or SYSTEMS may experience environmental conditions within the expected range at any time, and for extended periods of time. As with atmospheric pressure and humidity, the user of the EQUIPMENT and/or SYSTEM may not be aware of ambient levels on a continuous basis. The IMMUNITY TEST LEVELS specified in this standard (IEC 60601-1-2 TEST LEVELS) represent the range found in the general medical use environment. Therefore, under these conditions, the performance of the EQUIPMENT and/or SYSTEM would also be expected to be normal.

IEC 60513 states that the distinction between safety and performance standards is often unclear. EQUIPMENT and/or SYSTEMS are used in the practice of medicine because they provide needed FUNCTIONS. If an EQUIPMENT and/or SYSTEM does not provide its needed FUNCTION, because of a lack of IMMUNITY to events expected in the normal use environment, this interferes with the practice of medicine and cannot be considered an acceptable situation. Therefore, this second edition of IEC 60601-1-2 departs from the first edition by establishing a minimum baseline of performance in the presence of expected levels of ELECTROMAGNETIC DISTURBANCE.

This second edition recognizes that there is a shared responsibility between manufacturers, customers, and users to ensure that EQUIPMENT and/or SYSTEMS are designed and operated as intended. The EQUIPMENT and/or SYSTEM manufacturer’s

responsibility is to design and manufacture to meet the requirements of this standard and to disclose information to the customer and/or user so that a compatible ELECTROMAGNETIC ENVIRONMENT can be maintained in order that the EQUIPMENT and/or SYSTEM will perform as intended. Because the practice of medicine involves many specialities, there will by necessity be EQUIPMENT and/or SYSTEMS that are designed to perform a variety of FUNCTIONS. Some FUNCTIONS involve, for example, measurement of signals from a PATIENT that are of very low levels when compared to ELECTROMAGNETIC NOISE levels that can be coupled into EQUIPMENT and/or SYSTEMS during the ELECTROMAGNETIC IMMUNITY testing specified in this standard. Because of the proven benefits of many such EQUIPMENT and/or SYSTEMS, this standard allows the IMMUNITY TEST LEVELS to be lowered, provided there is sufficient justification based on physical, technological and/or physiological limitations. In this case, the manufacturer is required to disclose the levels at which the EQUIPMENT and/or SYSTEM meets the performance requirements of this standard and to specify the characteristics of the ELECTROMAGNETIC use environment and how this environment is established, in which the EQUIPMENT and/or SYSTEM will perform as intended. This standard also recognizes that for certain environments, higher IMMUNITY LEVELS may be required. Research necessary to determine how to identify the environments that may require higher IMMUNITY LEVELS, as well as what the levels should be, is in progress.

Finally, this standard recognizes that for some EQUIPMENT and/or SYSTEMS, higher levels of IMMUNITY may be necessary even for use in the general medical use environment. This has been addressed by additional requirements for LIFE-SUPPORTING EQUIPMENT and/or SYSTEMS in this standard.

This standard is based on existing IEC standards prepared by SC 62A, TC 77 (Electromagnetic compatibility between electrical equipment including networks) and CISPR (International special committee on radio interference).

The ELECTROMAGNETIC COMPATIBILITY requirements specified by this standard are generally applicable to EQUIPMENT and/or SYSTEMS as described in Subclause 1.201. For certain types of EQUIPMENT and/or SYSTEMS, these requirements may need to be modified by the special requirements of a Particular Standard. Writers of Particular Standards are encouraged to refer to Annex DDD for guidance in the application of this standard.

MEDICAL ELECTRICAL EQUIPMENT**Part 1: General requirements for safety****2. Collateral Standard:****Electromagnetic compatibility — Requirements and tests****SECTION 1: GENERAL****1 Scope and object*****1.201 Scope**

This standard applies to ELECTROMAGNETIC COMPATIBILITY of MEDICAL ELECTRICAL EQUIPMENT and/or MEDICAL ELECTRICAL SYSTEMS, hereinafter referred to as EQUIPMENT and/or SYSTEM(S).

1.202 Object

This standard specifies requirements and tests for ELECTROMAGNETIC COMPATIBILITY of EQUIPMENT and/or SYSTEMS and serves as the basis of ELECTROMAGNETIC COMPATIBILITY requirements and tests in Particular Standards.

2 Terminology and definitions

For the purposes of this standard, the following definitions apply:

2.201 (IMMUNITY) COMPLIANCE LEVEL

A level less than or equal to the IMMUNITY LEVEL for which the EQUIPMENT and/or SYSTEM meets the requirements of the applicable subclause of Subclause 36.202, *IMMUNITY*. (Additional requirements for COMPLIANCE LEVELS are specified in Subclause 6.8.201.1, *ACCOMPANYING DOCUMENTS, General*.)

2.202 CRITICAL FUNCTION (of an EQUIPMENT and/or SYSTEM)

A FUNCTION, the DEGRADATION of which could affect the safety and/or the safety-related performance of the EQUIPMENT and/or SYSTEM in NORMAL USE. (CRITICAL FUNCTIONS are further specified in Subclause 3.201.2, *CRITICAL FUNCTIONS*.)

***2.203 DEGRADATION (of performance)**

An undesired departure in the operational performance of an EQUIPMENT and/or SYSTEM from its intended performance. [IEV 161-01-19, modified]

2.204 EFFECTIVE RADIATED POWER: ERP (abbreviation)

The power required at the input of a lossless reference antenna to produce, in a given direction at any specified distance, the same power flux density as that radiated by a given device.

NOTE As used by the ITU and as used in Chapter 712 of the IEC, the term "effective radiated power" appears without qualification only when the reference antenna is a half-wave dipole.

[IEV 161-04-16, modified]

2.205 ELECTROMAGNETIC COMPATIBILITY: EMC (abbreviation)

The ability of an EQUIPMENT and/or SYSTEM to function satisfactorily in its ELECTROMAGNETIC ENVIRONMENT without introducing intolerable ELECTROMAGNETIC DISTURBANCES to anything in that environment.

[IEV 161-01-07, modified]

***2.206 ELECTROMAGNETIC DISTURBANCE**

Any electromagnetic phenomenon that may degrade the performance of a device, equipment or system.

NOTE An ELECTROMAGNETIC DISTURBANCE may be an ELECTROMAGNETIC NOISE, an unwanted signal or a change in the propagation medium itself.

[IEV 161-01-05, modified]

2.207 (ELECTROMAGNETIC) EMISSION

The phenomenon by which electromagnetic energy emanates from a source.

[IEV 161-01-08]

2.208 ELECTROMAGNETIC ENVIRONMENT

The totality of electromagnetic phenomena existing at a given location.

[IEV 161-01-01]

2.209 ELECTROMAGNETIC NOISE

A time-varying electromagnetic phenomenon apparently not conveying information and which may be superimposed on or combined with a wanted signal. [IEV 161-01-02]

***2.210 EXCLUSION BAND**

A frequency band for intentional receivers of RF electromagnetic energy that extends from minus 5 % to plus 5 % of the frequency, or frequency band, of reception for

frequencies of reception greater than or equal to 80 MHz and from minus 10 % to plus 10 % of the frequency, or frequency band, of reception for frequencies of reception less than 80 MHz.

NOTE Other definitions of this term are sometimes used for other purposes in National and/or Regional Radio Regulations.

***2.211 FUNCTION (of an EQUIPMENT and/or SYSTEM)**

A clinically significant feature that the EQUIPMENT and/or SYSTEM is intended to provide.

2.212 IEC 60601-1-2 TEST LEVEL

A test level specified by this standard in Subclause 36.202, *IMMUNITY*.

2.213 IMMUNITY (to a disturbance)

The ability of an EQUIPMENT and/or SYSTEM to perform without DEGRADATION in the presence of an ELECTROMAGNETIC DISTURBANCE. [IEV 161-01-20, modified]

2.214 IMMUNITY LEVEL

The maximum level of a given ELECTROMAGNETIC DISTURBANCE incident on a particular device, equipment or system for which it remains capable of operating at a required degree of performance. [IEV 161-03-14]

2.215 IMMUNITY TEST LEVEL

The level of a test signal used to simulate an ELECTROMAGNETIC DISTURBANCE when performing an IMMUNITY test. [IEV 161-04-41, modified]

2.216 INFORMATION TECHNOLOGY EQUIPMENT: ITE (abbreviation)

Equipment designed for the purpose of:

- a) receiving data from an external source (such as a data input line or via a keyboard);
- b) performing some processing functions on the received data (such as computation, data transformation or recording, filing, sorting, storage, transfer of data);
- c) providing a data output (either to other equipment or by the reproduction of data or images).

NOTE This definition includes electrical or electronic units or systems that predominantly generate a multiplicity of periodic binary pulsed electrical or electronic waveforms and are designed to perform data

processing functions such as word processing, electronic computation, data transformation, recording, filing, sorting, storage, retrieval and transfer, and reproduction of data as images.

[IEV 161-05-04]

***2.217 LARGE EQUIPMENT and/or SYSTEM**

An EQUIPMENT and/or SYSTEM that cannot fit within a 2 m x 2 m x 2,5 m volume, excluding cables. This includes distributed SYSTEMS.

***2.218 LIFE-SUPPORTING EQUIPMENT and/or SYSTEM**

An EQUIPMENT and/or SYSTEM that includes at least one FUNCTION that is intended to actively keep alive or resuscitate PATIENTS and the failure of which to comply with the requirements of Subclause 36.202.1 j), *Compliance criteria*, is likely to lead to serious injury or death of a PATIENT.

2.219 LOW VOLTAGE

A line-to-line or line-to-neutral voltage that is less than or equal to 1000 V a.c. or 1500 V d.c.

***2.220 MEDICAL ELECTRICAL SYSTEM (hereinafter referred to as SYSTEM)**

Combination of items of equipment, at least one of which must be MEDICAL ELECTRICAL EQUIPMENT and interconnected by FUNCTIONAL CONNECTION or use of a MULTIPLE PORTABLE SOCKET-OUTLET.

NOTE Equipment when mentioned in connection with a SYSTEM, should be taken to include EQUIPMENT

[IEC 60601-1-1; Subclause 2.201]

***2.221 OPERATING FREQUENCY**

The fundamental frequency of a signal, electrical or non-electrical, that is set in an EQUIPMENT and/or SYSTEM intended to control a physiological parameter.

***2.222 PATIENT-COUPLED EQUIPMENT and/or SYSTEM**

An EQUIPMENT and/or SYSTEM that contains at least one APPLIED PART whereby contact with the PATIENT provides a sensing or treatment point necessary for the normal operation of the EQUIPMENT and/or SYSTEM and provides a path for electromagnetic energy, whether coupled conductively, capacitively and/or inductively and whether intended or unintended.

***2.223 PHYSIOLOGICAL SIMULATION FREQUENCY**

The fundamental frequency of a signal, electrical or non-electrical, used to simulate a physiological parameter such that the EQUIPMENT and/or SYSTEM will operate in a manner consistent with use on a PATIENT.

***2.224 PUBLIC MAINS NETWORK**

LOW VOLTAGE electricity power lines to which all categories of consumers have access.

2.225 RADIO FREQUENCY: RF (abbreviation)

A frequency in the portion of the electromagnetic spectrum that is between the audio-frequency portion and the infrared portion. A frequency useful for radio transmission.

NOTE The limits are generally accepted to be 9 kHz to 3 000 GHz.

3 General requirements

3.201 General requirements for ELECTROMAGNETIC COMPATIBILITY of EQUIPMENT and/or SYSTEMS

***3.201.1 ELECTROMAGNETIC COMPATIBILITY**

EQUIPMENT and/or SYSTEMS shall not emit ELECTROMAGNETIC DISTURBANCES that could affect radio services, other equipment, or the CRITICAL FUNCTIONS of other EQUIPMENT and/or SYSTEMS. CRITICAL FUNCTIONS of EQUIPMENT and/or SYSTEMS shall have adequate IMMUNITY to ELECTROMAGNETIC DISTURBANCES.

Note The ELECTROMAGNETIC ENVIRONMENT as specified by the IEC 60601-1-2 TEST LEVELS is considered a NORMAL CONDITION and not a SINGLE FAULT CONDITION.

Compliance is considered to exist if the requirements of this standard are met.

***3.201.2 CRITICAL FUNCTIONS**

CRITICAL FUNCTIONS of EQUIPMENT and/or SYSTEMS shall be identified by a risk analysis. This risk analysis is not required if all FUNCTIONS of the EQUIPMENT and/or SYSTEM are tested in accordance with Subclause 36.202, IMMUNITY.

Compliance is checked by inspection of the documents for this risk analysis or, if this risk analysis is not performed, by inspection of the documents to verify that all FUNCTIONS of the EQUIPMENT and/or SYSTEM have been tested in accordance with Subclause 36.202, IMMUNITY.

3.201.3 MEDICAL ELECTRICAL EQUIPMENT

MEDICAL ELECTRICAL EQUIPMENT shall meet the requirements of this standard.

Compliance is considered to exist if the requirements of this standard are met.

***3.201.4 Non-medical equipment**

Non-medical equipment that is supplied as part of a SYSTEM and the EMISSIONS and/or IMMUNITY of which can be reasonably expected not to affect the CRITICAL FUNCTIONS of the SYSTEM or increase the EMISSIONS of the EQUIPMENT is exempt from the EMC testing requirements of this standard, provided the non-medical equipment complies with applicable international EMC standards. The determination of reasonable expectation not to affect the CRITICAL FUNCTIONS of the SYSTEM shall be based upon a risk analysis. This risk analysis is not required if the non-medical equipment supplied as part of a SYSTEM is tested for EMC in accordance with this standard.

Compliance is checked by inspection of the documents for this risk analysis and other appropriate documents or certificates or, if this risk analysis is not performed, by inspection of the documents to verify that the non-medical equipment has been tested in accordance with this standard.

6 Identification, marking and documents

6.1.201 Marking on the outside of EQUIPMENT or EQUIPMENT parts

***6.1.201.1 Marking on the outside of EQUIPMENT or EQUIPMENT parts that include RF transmitters and/or that apply RF electromagnetic energy for diagnosis and/or treatment**

EQUIPMENT and/or SYSTEMS that include RF transmitters and/or that intentionally apply RF electromagnetic energy for diagnosis and/or treatment shall be labelled with the following symbol for non-ionizing radiation [IEC 60878-03-04]:



6.1.201.2 Marking on the outside of EQUIPMENT or EQUIPMENT parts for which the connector testing exemption specified in Subclause 36.202.2 b) 3 is used

For EQUIPMENT and/or SYSTEMS for which the connector testing exemption specified in Subclause 36.202.2 b) 3 is used, the following symbol for ESD sensitivity shall be applied adjacent to each connector for which the testing exemption is used [IEC 60417-5134]:



6.1.201.3 Marking on the outside of EQUIPMENT and/or SYSTEMS that are specified for use only in a shielded location

EQUIPMENT and/or SYSTEMS specified for use only in a shielded location shall be labelled with a warning that they should be used only in the specified type of shielded location. (See Subclause 6.8.201.1 c), *Requirements applicable to EQUIPMENT and/or SYSTEMS specified for use only in a shielded location.*)

Compliance is checked by inspection.

6.8.201 ACCOMPANYING DOCUMENTS

6.8.201.1 General

a) Requirements applicable to all EQUIPMENT and/or SYSTEMS

For all EQUIPMENT and/or SYSTEMS, the ACCOMPANYING DOCUMENTS shall include the following information:

- *1. A list of all cables and maximum lengths of cables (if applicable), transducers, and other ACCESSORIES with which the manufacturer of the EQUIPMENT and/or SYSTEM claims compliance with the requirements of Subclauses 36.201, *EMISSIONS*, and 36.202, *IMMUNITY*. ACCESSORIES that do not affect compliance with the requirements of these subclauses need not be listed. ACCESSORIES, transducers, and cables may be specified either generically (e.g. shielded serial cable, load impedance) or specifically (e.g. by manufacturer and model or part number);

NOTE Transducers and cables sold by the manufacturer of the EQUIPMENT and/or SYSTEM as replacement parts for internal components need not be listed.

- *2. A warning that the use of ACCESSORIES, transducers, and cables other than those specified, with the exception of transducers and cables sold by the manufacturer of the EQUIPMENT and/or SYSTEM as replacement parts for internal components, may result in increased EMISSION and/or decreased IMMUNITY of the EQUIPMENT and/or SYSTEM;
- *3. Table 201, with the modifications specified below.^{1,2} (The flowchart in Figure 201a provides a step-by-step procedure for completing Table 201 for CISPR 11 EQUIPMENT and/or SYSTEMS. The flowchart in Figure 201b

¹ See Annex BBB for examples. These modifications should be performed in the order in which they appear.

² Row numbers refer to those in Table 1 before modifications are made.

provides a step-by-step procedure for completing Table 201 for CISPR 14 and CISPR 15 EQUIPMENT.)

- For CISPR 11 EQUIPMENT and/or SYSTEMS, “[EQUIPMENT and/or SYSTEM]” shall be replaced with the trade name and/or model number of the EQUIPMENT and/or SYSTEM.
- For CISPR 14 and CISPR 15 EQUIPMENT, “[EQUIPMENT]” shall be replaced with the trade name and/or model number of the EQUIPMENT.
- For CISPR 11 Group 1 EQUIPMENT and/or SYSTEMS, rows 4, 10, and 11 shall be deleted.
- For CISPR 11 Group 2 EQUIPMENT and/or SYSTEMS, rows 3, 10, and 11 shall be deleted.
- For EQUIPMENT that complies with CISPR 14, rows 3 through 5 and row 11 shall be deleted
- For EQUIPMENT that complies with CISPR 15, rows 3 through 5 and row 10 shall be deleted.
- For CISPR 11 EQUIPMENT and/or SYSTEMS that comply with Class A, “[A or B]” in column 2 of row 5 shall be replaced with “A.” For CISPR 11 EQUIPMENT and/or SYSTEMS that comply with Class B, “[A or B]” shall be replaced with “B.”
- For EQUIPMENT and/or SYSTEMS that comply with IEC 61000-3-2, “[Complies and/or Not applicable]” in column 2 of row 6 shall be replaced with the class of the EQUIPMENT and/or SYSTEM according to IEC 61000-3-2. For EQUIPMENT and/or SYSTEMS that comply with IEC 61000-3-3, “[Complies and/or Not applicable]” in column 2 of row 7 shall be replaced with “Complies.” For EQUIPMENT and/or SYSTEMS for which IEC 61000-3-2 and IEC 61000-3-3 are not applicable, “[Complies and/or Not applicable]” shall be replaced with “Not applicable.”
- For CISPR 11 EQUIPMENT and/or SYSTEMS, column 3 of rows 5, 6, and 7 shall be merged into one cell. For CISPR 11 EQUIPMENT and/or SYSTEMS that comply with Class B and with IEC 61000-3-2 and IEC 61000-3-3, the text in column 3 of row 8 shall be moved into the merged cell. For CISPR 11 EQUIPMENT and/or SYSTEMS that comply with Class A or for which IEC 61000-3-2 and IEC 61000-3-3 are not applicable, the text in column 3 of row 9 shall be moved into the merged cell.
- For CISPR 14 or CISPR 15 EQUIPMENT, column 3 of rows 6 and 7 shall be merged into one cell. For CISPR 14 or CISPR 15 EQUIPMENT that comply with IEC 61000-3-2 and with IEC 61000-3-3, the text in column 3

of row 8 shall be moved into the merged cell. For CISPR 14 or CISPR 15 EQUIPMENT for which IEC 61000-3-2 and IEC 61000-3-3 are not applicable, the text in column 3 of row 9 shall be moved into the merged cell.

- For EQUIPMENT and/or SYSTEMS specified for use only in a shielded location and for which the electromagnetic radiation disturbance allowance and/or the mains terminal disturbance voltage allowance in Subclause 36.201.1 a) 4, *EQUIPMENT and/or SYSTEMS specified for use only in a shielded location*, is used, the text specified by Subclause 6.8.201.1 c) 2 shall be added.
 - Rows 8 and 9 shall be deleted.
 - The row numbers shall be deleted.
- *4. A warning that the EQUIPMENT and/or SYSTEM should not be used adjacent to or stacked with other equipment, and that if adjacent or stacked use is necessary, the EQUIPMENT and/or SYSTEM should be observed to verify normal operation in the configuration in which it will be used;

NOTE The manufacturer of the EQUIPMENT and/or SYSTEM may provide a description and/or list of equipment with which the EQUIPMENT and/or SYSTEM has been tested in a stacked and/or adjacent configuration and with which stacked and/or adjacent use is permitted.

- *5. A justification for each COMPLIANCE LEVEL that is lower than the IEC 60601-1-2 TEST LEVEL for that IMMUNITY test. These justifications shall be based only on physical, technological and/or physiological limitations that prevent compliance at the IEC 60601-1-2 TEST LEVEL;
- *6. Table 202, completed as specified below.³ (The flowchart in Figure 202 provides a step-by-step procedure for completing Table 202.)
- “[EQUIPMENT and/or SYSTEM]” shall be replaced with the trade name and/or model number of the EQUIPMENT and/or SYSTEM.

NOTE “[EQUIPMENT and/or SYSTEM]” appears four times in Table 202.

- *- Column 3 of Table 202 shall be filled in with the IMMUNITY COMPLIANCE LEVEL for each test in accordance with the requirements of Subclause 6.8.201.1, *ACCOMPANYING DOCUMENTS, General*, and of Subclause 36.202, *IMMUNITY*. If a COMPLIANCE LEVEL lower or higher than the IEC 60601-1-2 TEST LEVEL is claimed, it shall be one of the levels listed in the referenced basic EMC IMMUNITY standard unless the COMPLIANCE LEVEL is outside the range of levels listed. If the COMPLIANCE LEVEL is

³ See Annex BBB for an example.

outside the range of levels listed in the referenced basic EMC IMMUNITY standard, the actual IMMUNITY LEVEL shall be stated, rounded to one significant digit. If according to Subclause 36.202, *IMMUNITY*, or the scope of the EMC basic standard, a test does not apply to the EQUIPMENT and/or SYSTEM, or it is not possible to perform the test on the EQUIPMENT and/or SYSTEM, columns 3 and 4 of Table 202 shall state that the test is not applicable.

- *- For the electrostatic discharge (ESD) IMMUNITY test (IEC 61000-4-2), the electrical fast transient/burst IMMUNITY test (IEC 61000-4-4), the surge IMMUNITY test (IEC 61000-4-5), the voltage dips, short interruptions and voltage variations IMMUNITY test (IEC 61000-4-11), and the power frequency magnetic fields IMMUNITY test (IEC 61000-4-8):
 - If a COMPLIANCE LEVEL is lower than an IMMUNITY TEST LEVEL specified in Subclause 36.202.2, *Electrostatic discharge (ESD)*; 36.202.4, *Electrical fast transients and bursts*; 36.202.5, *Surges*; 36.202.7, *Voltage dips, short interruptions and voltage variations on power supply input lines*; and/or 36.202.8.1, *Power frequency magnetic fields*; the text in column 4 in the corresponding row of Table 202 shall be replaced with a description of the actions the customer and/or user must take to reduce environmental levels of the DISTURBANCE so that they are less than or equal to the COMPLIANCE LEVEL listed in column 3.
 - If a COMPLIANCE LEVEL is higher than an IMMUNITY TEST LEVEL specified in Subclause 36.202.2, *Electrostatic discharge (ESD)*; 36.202.4, *Electrical fast transients and bursts*; 36.202.5, *Surges*; 36.202.7, *Voltage dips, short interruptions and voltage variations on power supply input lines*; and/or 36.202.8.1, *Power frequency magnetic fields*; the text in column 4 in the corresponding row of Table 202 may be replaced with a description of the environment for which the EQUIPMENT and/or SYSTEM is suitable.
- *b). Requirements applicable to EQUIPMENT and/or SYSTEMS other than those specified for use only in a shielded location

For EQUIPMENT and/or SYSTEMS other than those specified for use only in a shielded location, the ACCOMPANYING DOCUMENTS shall include the following information:

The applicable tables, 203a and 204a or 203b and 204b. Tables 203a and 204a shall be used for LIFE-SUPPORTING EQUIPMENT and/or SYSTEMS. Tables 203b and 204b shall be used for EQUIPMENT and/or SYSTEMS that are not LIFE-SUPPORTING. The tables shall be completed for the conducted and radiated RF IMMUNITY tests

as specified below.⁴ (The flowchart in Figure 203a provides a step-by-step procedure for completing Tables 203a and 204a and the flowchart in Figure 203b provides a step-by-step procedure for completing Tables 203b and 204b.)

1. “[EQUIPMENT and/or SYSTEM]” shall be replaced with the trade name and/or model number of the EQUIPMENT and/or SYSTEM.

NOTE “[EQUIPMENT and/or SYSTEM]” appears six times in Tables 203a and 203b and once in the titles of Tables 204a and 204b.

2. Column 3 of Table 203a or 203b, as applicable, shall be filled in with the IMMUNITY COMPLIANCE LEVEL in accordance with the requirements of Subclause 6.8.201.1, *ACCOMPANYING DOCUMENTS, General*, and of Subclause 36.202, *IMMUNITY*. If a COMPLIANCE LEVEL lower or higher than the IEC 60601-1-2 TEST LEVEL is claimed, it shall be one of the levels listed in the referenced basic EMC IMMUNITY standard unless the COMPLIANCE LEVEL is outside the range of levels listed. If the COMPLIANCE LEVEL is outside the range of levels listed in the referenced basic EMC IMMUNITY standard, the actual IMMUNITY LEVEL shall be stated, rounded to one significant digit.
 3. The expressions in square brackets ([]) that contain V_1 , V_2 , and E_1 in column 4 of Table 203a or 203b, as applicable, and in the first row of Table 204a or 204b, as applicable, shall be calculated, rounded to two significant digits, and the results substituted in place of the corresponding expressions. V_1 and V_2 are the COMPLIANCE LEVELS for the IEC 61000-4-6 test and E_1 is the COMPLIANCE LEVEL for the IEC 61000-4-3 test. V_1 and V_2 are in V and E_1 is in V/m. The value of V_1 shall also be substituted for “[V_1]” in the table footnote in Table 203a or 203b, as applicable.
 4. Table 204a or 204b, as applicable, shall be completed by calculating the distance corresponding to each entry in columns 2, 3, and 4 using the equation at the top of the column and the output power that appears in column 1 of that row. The calculated distances shall be rounded to two significant digits and entered in Table 204a or 204b, as applicable.
- c) Requirements applicable to EQUIPMENT and/or SYSTEMS specified for use only in a shielded location

For EQUIPMENT and/or SYSTEMS specified for use only in a shielded location, the ACCOMPANYING DOCUMENTS shall include the following information:

1. A warning that the EQUIPMENT and/or SYSTEM should be used only in the specified type of shielded location;

⁴ See Annex BBB for examples.

*2. If the electromagnetic radiation disturbance allowance and/or the mains terminal disturbance voltage allowance in Subclause 36.201.1 a) 4, *EQUIPMENT and/or SYSTEMS specified for use only in a shielded location*, is used:

- The following text, appended to the beginning of the text in column 3 of Table 201 in the merged cell of the IEC 61000-3-2 and IEC 61000-3-3 rows:

When installed in a shielded location with a minimum RF shielding effectiveness and, for each cable that exits the shielded location, a minimum RF filter attenuation of [shielding effectiveness / filter attenuation] dB from 150 kHz to 2,5 GHz,

where “[shielding effectiveness / filter attenuation]” shall be replaced with the highest value of RF shielding effectiveness and/or RF filter attenuation over the frequency band 150 kHz to 2,5 GHz that is required in order to meet all of the following:

- The electromagnetic radiation disturbance requirements of Subclause 36.201.1 a) 4;
- The mains terminal disturbance requirements of Subclause 36.201.1 a) 4;
- The radiated RF electromagnetic fields IMMUNITY requirements of Subclause 36.202.3 a) 3;
- The conducted disturbances, induced by RF fields IMMUNITY requirements of Subclause 36.202.6 a) 3.

The shielding effectiveness / filter attenuation value shall be in dB and shall be rounded to the nearest integer;⁵

- The following text, added to the CISPR row, after or below the CISPR class:

(The [EQUIPMENT and/or SYSTEM] in combination with the shielded location)

where “[EQUIPMENT and/or SYSTEM]” shall be replaced with the trade name and/or model number of the EQUIPMENT and/or SYSTEM;

⁵ This value is also used in Tables 5a and 5b (see Subclause 6.8.201.1 c) 4). See Subclause 36.201.1 a) 4, *EQUIPMENT and/or SYSTEMS specified for use only in a shielded location*, for additional requirements regarding claimed shielding effectiveness / filter attenuation values.

- The following note, added to the bottom of Table 201:

NOTE It is essential that the actual shielding effectiveness and filter attenuation of the shielded location be verified to assure that they meet the minimum specification.

- *3. A specification of the EMISSIONS characteristics of other equipment allowed inside the shielded location with the EQUIPMENT and/or SYSTEM, a list of specific equipment allowed and/or a list of types of equipment prohibited (see Subclause 36.202.3 a) 3, *EQUIPMENT and/or SYSTEMS specified for use only in a shielded location*), and a recommendation that a notice containing this information be posted at the entrance(s) to the shielded location;
- *4. The applicable table, 205a or 205b. Table 205a shall be used for LIFE-SUPPORTING EQUIPMENT and/or SYSTEMS. Table 205b shall be used for EQUIPMENT and/or SYSTEMS that are not LIFE-SUPPORTING. The tables shall be completed as follows:⁶

- “[EQUIPMENT and/or SYSTEM]” shall be replaced with the trade name and/or model number of the EQUIPMENT and/or SYSTEM;

NOTE “[EQUIPMENT and/or SYSTEM]” appears six times in Tables 205a and 205b.

- Column 3 of Table 205a or 205b, as applicable, shall be filled in with the IMMUNITY COMPLIANCE LEVEL in accordance with the requirements of Subclause 6.8.201.1, *ACCOMPANYING DOCUMENTS, General*, and of Subclause 36.202, *IMMUNITY*. If an IMMUNITY COMPLIANCE LEVEL lower or higher than the IEC 60601-1-2 TEST LEVEL is claimed, it shall be one of the levels listed in the referenced basic EMC IMMUNITY standard unless the COMPLIANCE LEVEL is outside the range of levels listed. If the COMPLIANCE LEVEL is outside the range of levels listed in the referenced basic EMC IMMUNITY standard, the actual IMMUNITY LEVEL shall be stated, rounded to one significant digit;
- *- In column 4 of Table 205a or 205b, as applicable, “[shielding effectiveness / filter attenuation]” shall be replaced with the value in dB determined as specified in 2, above; “[appropriate section of ACCOMPANYING DOCUMENTS]” shall be replaced with a reference to the location in the ACCOMPANYING DOCUMENTS where the information required by 6.8.201.1 c) 3 can be found; and “[field strength]” shall be replaced with the maximum field strength in V/m, rounded to one significant digit, of fixed RF transmitters that when attenuated by the specified minimum RF shielding effectiveness / filter attenuation, will not exceed the COMPLIANCE LEVEL for any of the frequency ranges. For

⁶ See Annex BBB for an example.

calculating “[field strength]”, the COMPLIANCE LEVELS for the IEC 61000-4-6 test shall be considered to be in units of V/m;

- In table footnote b of Table 205a or table footnote a of Table 205b, as applicable, “[field strength]” shall be replaced as specified above for column 4 of the table.

- d) Requirements applicable to EQUIPMENT and/or SYSTEMS that intentionally apply RF energy for diagnosis and/or treatment

For EQUIPMENT and/or SYSTEMS that intentionally apply RF energy for diagnosis and/or treatment, the ACCOMPANYING DOCUMENTS shall include guidelines for avoiding or identifying and resolving adverse electromagnetic effects on other equipment that may result from operation of the EQUIPMENT and/or SYSTEM.

- e) Requirements applicable to EQUIPMENT and/or SYSTEMS that intentionally receive RF electromagnetic energy for the purpose of their operation

For EQUIPMENT and/or SYSTEMS that intentionally receive RF electromagnetic energy for the purpose of their operation, the ACCOMPANYING DOCUMENTS shall include the following information:

1. Each frequency and/or frequency band of reception; the preferred frequency and/or frequency band, if applicable; and the bandwidth of the receiving section of the EQUIPMENT and/or SYSTEM in those bands.
2. A warning that the EQUIPMENT and/or SYSTEM may be interfered with by other equipment, even if that other equipment complies with CISPR EMISSION requirements;

- f) Requirements applicable to EQUIPMENT and/or SYSTEMS that include RF transmitters

For EQUIPMENT and/or SYSTEMS that include RF transmitters, the ACCOMPANYING DOCUMENTS shall include each frequency and/or frequency band of transmission, the type and frequency characteristics of the modulation, and the EFFECTIVE RADIATED POWER;

- *g) Requirements applicable to cables, transducers, and other ACCESSORIES that could affect compliance with the requirements of Subclauses 36.201, *EMISSIONS*, and 36.202, *IMMUNITY*

For cables, transducers, and other ACCESSORIES that could affect compliance with the requirements of Subclauses 36.201, *EMISSIONS*, and 36.202, *IMMUNITY*, the ACCOMPANYING DOCUMENTS shall include the following information:

1. A list of all EQUIPMENT and/or SYSTEMS with which the ACCESSORY,

transducer, and/or cable may be used and that are claimed by the manufacturer of the ACCESSORY, transducer, and/or cable to be in compliance with the requirements of Subclauses 36.201, *EMISSIONS*, and 36.202, *IMMUNITY* when used with the ACCESSORY, transducer, and/or cable. References shall be specific (e.g. by manufacturer and model or part number);

2. A warning that the use of the ACCESSORY, transducer, and/or cable with EQUIPMENT and/or SYSTEMS other than those specified may result in increased EMISSIONS and/or decreased IMMUNITY of the EQUIPMENT and/or SYSTEM.

h) Requirements applicable to LARGE, PERMANENTLY-INSTALLED EQUIPMENT and/or SYSTEMS

For LARGE, PERMANENTLY-INSTALLED EQUIPMENT and/or SYSTEMS for which the exemption specified in Subclause 36.202.3 b) 1 is used, the ACCOMPANYING DOCUMENTS shall include the following information:

1. A statement that an exemption has been used and that the EQUIPMENT and/or SYSTEM has not been tested for radiated RF IMMUNITY over the entire frequency range 80 MHz to 2,5 GHz;
2. A warning that the EQUIPMENT and/or SYSTEM has been tested for radiated RF IMMUNITY only at selected frequencies;
- *3. A list of the transmitters and/or equipment used as RF test sources and the frequency and modulation characteristics of each source.

6.8.201.2 Instructions for use

a) Requirements applicable to all EQUIPMENT and/or SYSTEMS

The *Instructions for use* shall include a statement that medical electrical equipment needs special precautions regarding EMC and needs to be installed and put into service according to the EMC information provided in the accompanying documents.

b) Requirements applicable to EQUIPMENT and/or SYSTEMS for which the connector testing exemption specified in Subclause 36.202.2 b) 3 is used

For EQUIPMENT and/or SYSTEMS for which the connector testing exemption specified in Subclause 36.202.2 b) 3 is used, the *Instructions for use* shall include the following:

1. A warning that pins of connectors identified with the ESD warning symbol

should not be touched and that connections should not be made to these connectors unless ESD precautionary procedures are used;

- *2. A specification of the ESD precautionary procedures;
- *3. A recommendation that all staff involved receive an explanation of the ESD warning symbol and training in ESD precautionary procedures;
- *4. A specification of the minimum contents of ESD precautionary procedure training.

c) Minimum amplitude and/or value of PATIENT physiological signal

For EQUIPMENT and/or SYSTEMS without a manual sensitivity adjustment and for which the manufacturer specifies a minimum amplitude and/or value of the PATIENT physiological signal (see Subclause 36.202.1 g), *PATIENT simulation*, first dash), the *Instructions for use* shall include the following:

- 1. The minimum amplitude and/or value of PATIENT physiological signal;
- 2. A warning that operation of the device below this amplitude and/or value may cause inaccurate results.

Compliance is checked by inspection.

SECTIONS 2 to 4: Not used

**Guidance and Manufacturer's Declaration
Electromagnetic Emissions
IEC 60601-1-2**

Row

1	The [EQUIPMENT and/or SYSTEM] is suitable for use in the specified electromagnetic environment. The customer and/or the user of the [EQUIPMENT and/or SYSTEM] should assure that it is used in an electromagnetic environment as described below:		
2	Emissions Test	Compliance	Electromagnetic Environment Guidance
3	RF emissions CISPR 11	Group 1	The [EQUIPMENT and/or SYSTEM] uses RF energy only for its internal function. Therefore, its RF emissions are very low and are not likely to cause any interference in nearby electronic equipment.
4	RF emissions CISPR 11	Group 2	The [EQUIPMENT and/or SYSTEM] must emit electromagnetic energy in order to perform its intended function. Nearby electronic equipment may be affected.
5	RF emissions CISPR 11	Class [A or B]	
6	Harmonic emissions IEC 61000-3-2	[IEC 61000-3-2 class or Not applicable]	
7	Voltage fluctuations/ flicker emissions IEC 61000-3-3	[Complies or Not applicable]	
8		[See Subclause 6.8.201.1 a) 3 and/or Figure 201]	The [EQUIPMENT and/or SYSTEM] is suitable for use in all establishments, including domestic establishments and those directly connected to the public low-voltage power supply network that supplies buildings used for domestic purposes.
9		[See Subclause 6.8.201.1 a) 3 and/or Figure 201]	The [EQUIPMENT and/or SYSTEM] is suitable for use in all establishments other than domestic and those directly connected to the public low-voltage power supply network that supplies buildings used for domestic purposes.
10	RF emissions CISPR 14	Complies	The [EQUIPMENT] is not suitable for interconnection with other equipment.
11	RF emissions CISPR 15	Complies	The [EQUIPMENT] is not suitable for interconnection with other equipment.

**Table 201
For all EQUIPMENT and/or SYSTEMS**

(See Subclause 6.8.201 a) 3.)

Guidance and Manufacturer's Declaration
Electromagnetic Immunity
IEC 60601-1-2

The [EQUIPMENT and/or SYSTEM] is suitable for use in the specified electromagnetic environment. The customer and/or the user of the [EQUIPMENT and/or SYSTEM] should assure that it is used in an electromagnetic environment as described below:			
Immunity Test	IEC 60601-1-2 Test Level	Compliance Level	Electromagnetic Environment Guidance
Electrostatic discharge (ESD) IEC 61000-4-2	± 6 kV contact ± 8 kV air		Floors should be wood, concrete, or ceramic tile. If floors are covered with synthetic material, the relative humidity should be at least 30 %.
Electrical fast transient/burst IEC 61000-4-4	± 2 kV for power supply lines ± 1 kV for input/output lines		Mains power quality should be that of a typical commercial and/or hospital environment
Surge IEC 61000-4-5	± 1 kV differential mode ± 2 kV common mode		Mains power quality should be that of a typical commercial and/or hospital environment.
Voltage dips, short interruptions and voltage variations on power supply input lines IEC 61000-4-11	$< 5\%$ U_T ($> 95\%$ dip in U_T) for 0,5 cycle 40% U_T (60% dip in U_T) for 5 cycles 70% U_T (30% dip in U_T) for 25 cycles $< 5\%$ U_T ($> 95\%$ dip in U_T) for 5 sec		Mains power quality should be that of a typical commercial and/or hospital environment. If the user of the [EQUIPMENT and/or SYSTEM] requires continued operation during power mains interruptions, it is recommended that the [EQUIPMENT and/or SYSTEM] be powered from an uninterruptible power supply or a battery.
Power frequency (50/60 Hz) magnetic field IEC 61000-4-8	3 A/m		Power frequency magnetic fields should be at levels characteristic of a typical location in a typical commercial and/or hospital environment.
NOTE U_T is the a.c. mains voltage prior to application of the test level.			

Table 202
For all EQUIPMENT and/or SYSTEMS
(See Subclause 6.8.201 a) 6.)

**Guidance and Manufacturer's Declaration
Electromagnetic Immunity
IEC 60601-1-2**

The [EQUIPMENT and/or SYSTEM] is suitable for use in the specified electromagnetic environment. The customer and/or the user of the [EQUIPMENT and/or SYSTEM] should assure that it is used in an electromagnetic environment as described below:



Immunity Test	IEC 60601-1-2 Test Level	Compliance Level	Electromagnetic Environment Guidance
Conducted RF IEC 61000-4-6 Radiated RF IEC 61000-4-3	3 Vrms 150 kHz to 80 MHz outside ISM bands ^a 10 Vrms 150 kHz to 80 MHz in ISM bands ^a 10 V/m 80 MHz to 2,5 GHz	[V ₁] V [V ₂] V [E ₁] V/m	<p>Portable and mobile RF communications equipment should be used no closer to any part of the [EQUIPMENT and/or SYSTEM], including cables, than the recommended separation distance calculated from the equation appropriate for the frequency of the transmitter.</p> <p style="text-align: center;">Recommended Separation Distance</p> $d = \left[\frac{3,5 \cdot 1m}{V_1} \right] \sqrt{P}$ $d = \left[\frac{3,5}{E_1} \right] \sqrt{P}$ $d = \left[\frac{3,5}{E_1} \right] \sqrt{P} \quad 80 \text{ MHz to } 800 \text{ MHz}$ $d = \left[\frac{23}{E_2} \right] \sqrt{P} \quad 800 \text{ MHz to } 2,5 \text{ GHz}$ <p>where P is the maximum output power rating of the transmitter in watts (W) according to the transmitter manufacturer and d is the recommended separation distance in metres (m).^b</p> <p>Field strengths from fixed RF transmitters, as determined by an electromagnetic site survey,^c should be less than the compliance level in each frequency range.^d</p> <p>Interference may occur in the vicinity of equipment marked with the following symbol:</p> 
<p>^a The ISM (industrial, scientific and medical) bands between 150 kHz and 80 MHz are 6,765 MHz to 6,795 MHz; 13,553 MHz to 13,567 MHz; 26,957 MHz to 27,283 MHz; and 40,66 MHz to 40,70 MHz.</p> <p>^b The compliance levels in the ISM frequency bands between 150 kHz and 80 MHz and in the frequency range 80 MHz to 2,5 GHz are intended to decrease the likelihood that a portable communications device could cause interference if it is inadvertently brought into patient areas. For this reason, an additional factor of 10/3 is used in calculating the recommended separation distance for transmitters in these frequency ranges.</p> <p>^c Field strengths from fixed transmitters, such as base stations for radio (cellular/cordless) telephones and land mobile radios, amateur radio, AM and FM radio broadcast, and TV broadcast cannot be predicted theoretically with accuracy. To assess the electromagnetic environment due to fixed RF transmitters, an electromagnetic site survey should be considered. If the measured field strength in the location in which the [EQUIPMENT and/or SYSTEM] is used exceeds the applicable RF compliance level above, the [EQUIPMENT and/or SYSTEM] should be observed to verify normal operation. If abnormal performance is observed, additional measures may be necessary, such as re-orienting or relocating the [EQUIPMENT and/or SYSTEM].</p> <p>^d Over the frequency range 150 kHz to 80 MHz, field strengths should be less than [V₁] V/m.</p> <p>NOTE These guidelines may not apply in all situations. Electromagnetic propagation is affected by absorption and reflection from structures, objects, and people.</p>			

Table 203a
For LIFE-SUPPORTING EQUIPMENT and/or SYSTEMS
(See Subclause 6.8.201 b.)

Guidance and Manufacturer's Declaration
Electromagnetic Immunity
IEC 60601-1-2

The [EQUIPMENT and/or SYSTEM] is suitable for use in the specified electromagnetic environment. The customer and/or the user of the [EQUIPMENT and/or SYSTEM] should assure that it is used in an electromagnetic environment as described below:

Immunity Test	IEC 60601-1-2 Test Level	Compliance Level	Electromagnetic Environment Guidance
<p>Conducted RF IEC 61000-4-6</p> <p>Radiated RF IEC 61000-4-3</p>	<p>3 Vrms 150 kHz to 80 MHz</p> <p>3 V/m 80 MHz to 2,5 GHz</p>	<p>[V₁] V</p> <p>[E₁] V/m</p>	<p>Portable and mobile RF communications equipment should be used no closer to any part of the [EQUIPMENT and/or SYSTEM], including cables, than the recommended separation distance calculated from the equation appropriate for the frequency of the transmitter.</p> <p style="text-align: center;">Recommended Separation Distance</p> $d = \left[\frac{3,5 \cdot 1m}{V_1} \right] \sqrt{P}$ $d = \left[\frac{3,5}{E_1} \right] \sqrt{P} \quad 80 \text{ MHz to } 800 \text{ MHz}$ $d = \left[\frac{7}{E_2} \right] \sqrt{P} \quad 800 \text{ MHz to } 2,5 \text{ GHz}$ <p>where P is the maximum output power rating of the transmitter in watts (W) according to the transmitter manufacturer and d is the recommended separation distance in metres (m).</p> <p>Field strengths from fixed RF transmitters, as determined by an electromagnetic site survey,^a should be less than the compliance level in each frequency range.^b</p> <p>Interference may occur in the vicinity of equipment marked with the following symbol:</p> 

^a Field strengths from fixed transmitters, such as base stations for radio (cellular/cordless) telephones and land mobile radios, amateur radio, AM and FM radio broadcast, and TV broadcast cannot be predicted theoretically with accuracy. To assess the electromagnetic environment due to fixed RF transmitters, an electromagnetic site survey should be considered. If the measured field strength in the location in which the [EQUIPMENT and/or SYSTEM] is used exceeds the applicable RF compliance level above, the [EQUIPMENT and/or SYSTEM] should be observed to verify normal operation. If abnormal performance is observed, additional measures may be necessary, such as re-orienting or relocating the [EQUIPMENT and/or SYSTEM].

^b Over the frequency range 150 kHz to 80 MHz, field strengths should be less than [V₁] V/m.

NOTE These guidelines may not apply in all situations. Electromagnetic propagation is affected by absorption and reflection from structures, objects, and people.

Table 203b
For EQUIPMENT and/or SYSTEMS that are not LIFE-SUPPORTING
(See Subclause 6.8.201 b.)

**Recommended Separation Distances
between Portable and Mobile RF Communications Equipment
and the [EQUIPMENT and/or SYSTEM]
IEC 60601-1-2**

Frequency of Transmitter	150 kHz to 80 MHz Outside ISM Bands	150 kHz to 80 MHz In ISM Bands	80 MHz to 800 MHz	800 MHz to 2,5 GHz
Equation	$d = \left[\frac{3,5 \cdot 1m}{V_1} \right] \sqrt{P}$	$d = \left[\frac{3,5 \cdot 1m}{V_1} \right] \sqrt{P}$	$d = \left[\frac{3,5}{E_1} \right] \sqrt{P}$	$d = \left[\frac{23}{E_2} \right] \sqrt{P}$
Rated Maximum Output Power of Transmitter watts				
	Separation Distance metres	Separation Distance metres	Separation Distance metres	Separation Distance metres
0.01				
0.1				
1				
10				
100				

For transmitters rated at a maximum output power not listed above, the separation distance can be estimated using the equation in the corresponding column, where P is the maximum output power rating of the transmitter in watts (W) according to the transmitter manufacturer.

NOTE 1 The ISM (industrial, scientific and medical) bands between 150 kHz and 80 MHz are 6,765 MHz to 6,795 MHz; 13,553 MHz to 13,567 MHz; 26,957 MHz to 27,283 MHz; and 40,66 MHz to 40,70 MHz.

NOTE 2 An additional factor of 10/3 is used in calculating the recommended separation distance for transmitters in the ISM frequency bands between 150 kHz and 80 MHz and in the frequency range 80 MHz to 2,5 GHz to decrease the likelihood that a portable communications device could cause interference if it is inadvertently brought into patient areas.

NOTE 3 These guidelines may not apply in all situations. Electromagnetic propagation is affected by absorption and reflection from structures, objects, and people.

**Table 204a
For LIFE-SUPPORTING EQUIPMENT and/or SYSTEMS
(See Subclause 6.8.201 b.)**

**Recommended Separation Distances
between Portable and Mobile RF Communications Equipment
and the [EQUIPMENT and/or SYSTEM]
IEC 60601-1-2**

Frequency of Transmitter	150 kHz to 80 MHz	150 kHz to 800 MHz	800 MHz to 2,5 GHz
Equation	$d = \left[\frac{3,5 \cdot 1m}{V_1} \right] \sqrt{P}$	$d = \left[\frac{3,5}{E_1} \right] \sqrt{P}$	$d = \left[\frac{7}{E_2} \right] \sqrt{P}$
Rated Maximum Output Power of Transmitter watts	Separation Distance metres	Separation Distance metres	Separation Distance metres
0.01			
0.1			
1			
10			
100			
<p>For transmitters rated at a maximum output power not listed above, the separation distance can be estimated using the equation in the corresponding column, where P is the maximum output power rating of the transmitter in watts (W) according to the transmitter manufacturer.</p> <p>NOTE These guidelines may not apply in all situations. Electromagnetic propagation is affected by absorption and reflection from structures, objects, and people.</p>			

Table 204b
For EQUIPMENT and/or SYSTEMS that are not LIFE-SUPPORTING
(See Subclause 6.8.201 b.)

**Guidance and Manufacturer’s Declaration
Electromagnetic Immunity
IEC 60601-1-2**

<p>The [EQUIPMENT and/or SYSTEM] is suitable for use in the specified electromagnetic environment. The customer and/or the user of the [EQUIPMENT and/or SYSTEM] should assure that it is used in an electromagnetic environment as described below:</p>			
Immunity Test	IEC 60601-1-2 Test Level	Compliance Level	Electromagnetic Environment Guidance
<p>Conducted RF IEC 61000-4-6</p>	<p>3 Vrms 150 kHz to 80 MHz outside ISM bands^a</p>		<p>The [EQUIPMENT and/or SYSTEM] must be used only in a shielded location with a minimum RF shielding effectiveness and filter attenuation of [shielding effectiveness / filter attenuation] dB over the frequency range 150 kHz to 2,5 GHz. See [appropriate section of ACCOMPANYING DOCUMENTS].</p>
<p>Radiated RF IEC 61000-4-3</p>	<p>10 Vrms 150 kHz to 80 MHz in ISM bands^a</p> <p>10 V/m 80 MHz to 2,5 GHz</p>		<p>Field strengths outside the shielded location from fixed RF transmitters, as determined by an electromagnetic site survey, should be less than [field strength] V/m.^b</p> <p>Interference may occur in the vicinity of equipment marked with the following symbol:</p> <div style="text-align: center;">  </div>
<p>^a The ISM (industrial, scientific and medical) bands between 150 kHz and 80 MHz are 6,765 MHz to 6,795 MHz; 13,553 MHz to 13,567 MHz; 26,957 MHz to 27,283 MHz; and 40,66 MHz to 40,70 MHz.</p> <p>^b Field strengths from fixed transmitters, such as base stations for radio (cellular/cordless) telephones and land mobile radios, amateur radio, AM and FM radio broadcast, and TV broadcast cannot be predicted theoretically with accuracy. To assess the electromagnetic environment due to fixed RF transmitters, an electromagnetic site survey should be considered. If the measured field strength outside the shielded location in which the [EQUIPMENT and/or SYSTEM] is used exceeds [field strength] V/m, observe the [EQUIPMENT and/or SYSTEM] to verify normal operation. If abnormal performance is observed, additional measures may be necessary, such as relocating the [EQUIPMENT and/or SYSTEM] or using a shielded location with a higher RF shielding effectiveness and filter attenuation.</p> <p>NOTE 1 These guidelines may not apply in all situations. Electromagnetic propagation is affected by absorption and reflection from structures, objects, and people.</p> <p>NOTE 2 It is essential that the actual shielding effectiveness and filter attenuation of the shielded location be verified to assure that they meet the minimum specification.</p>			

**Table 205a
For LIFE-SUPPORTING EQUIPMENT and/or SYSTEMS
that are specified for use only in a shielded location
(See Subclause 6.8.201 c) 4.)**

**Guidance and Manufacturer's Declaration
Electromagnetic Immunity
IEC 60601-1-2**

<p>The [EQUIPMENT and/or SYSTEM] is suitable for use in the specified electromagnetic environment. The customer and/or the user of the [EQUIPMENT and/or SYSTEM] should assure that it is used in an electromagnetic environment as described below:</p>			
Immunity Test	IEC 60601-1-2 Test Level	Compliance Level	Electromagnetic Environment Guidance
<p>Conducted RF IEC 61000-4-6</p> <p>Radiated RF IEC 61000-4-3</p>	<p>3 Vrms 150 kHz to 80 MHz</p> <p>3 V/m 80 MHz to 2,5 GHz</p>		<p>The [EQUIPMENT and/or SYSTEM] must be used only in a shielded location with a minimum RF shielding effectiveness and filter attenuation of [shielding effectiveness / filter attenuation] dB over the frequency range 150 kHz to 2,5 GHz. See [appropriate section of ACCOMPANYING DOCUMENTS].</p> <p>Field strengths outside the shielded location from fixed RF transmitters, as determined by an electromagnetic site survey, should be less than [field strength] V/m.^a</p> <p>Interference may occur in the vicinity of equipment marked with the following symbol:</p> <div align="center">  </div>
<p>^a Field strengths from fixed transmitters, such as base stations for radio (cellular/cordless) telephones and land mobile radios, amateur radio, AM and FM radio broadcast, and TV broadcast cannot be predicted theoretically with accuracy. To assess the electromagnetic environment due to fixed RF transmitters, an electromagnetic site survey should be considered. If the measured field strength outside the shielded location in which the [EQUIPMENT and/or SYSTEM] is used exceeds [field strength] V/m, the [EQUIPMENT and/or SYSTEM] should be observed to verify normal operation. If abnormal performance is observed, additional measures may be necessary, such as relocating the [EQUIPMENT and/or SYSTEM] or using a shielded location with a higher RF shielding effectiveness and filter attenuation.</p> <p>NOTE 1 These guidelines may not apply in all situations. Electromagnetic propagation is affected by absorption and reflection from structures, objects, and people.</p> <p>NOTE 2 It is essential that the actual shielding effectiveness and filter attenuation of the shielded location be verified to assure that they meet the minimum specification.</p>			

**Table 205b
For EQUIPMENT and/or SYSTEMS that are not LIFE-SUPPORTING
and are specified for use only in a shielded location
(See Subclause 6.8.201 c) 4.)**

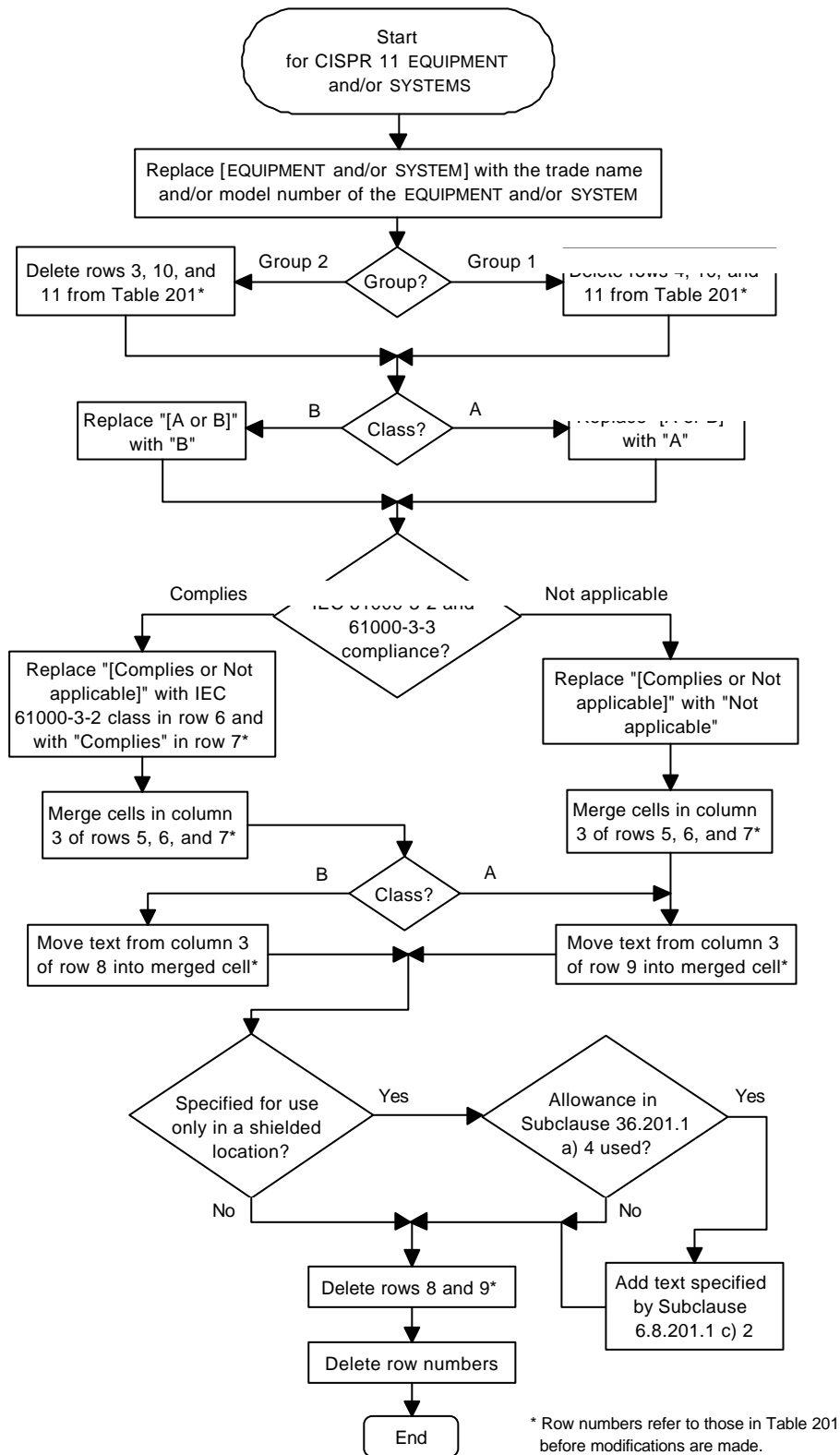

Figure 201a
Instructions for completing Table 201

**For CISPR 11 EQUIPMENT and/or SYSTEMS
(See Subclause 6.8.201.1 a) 3.)**

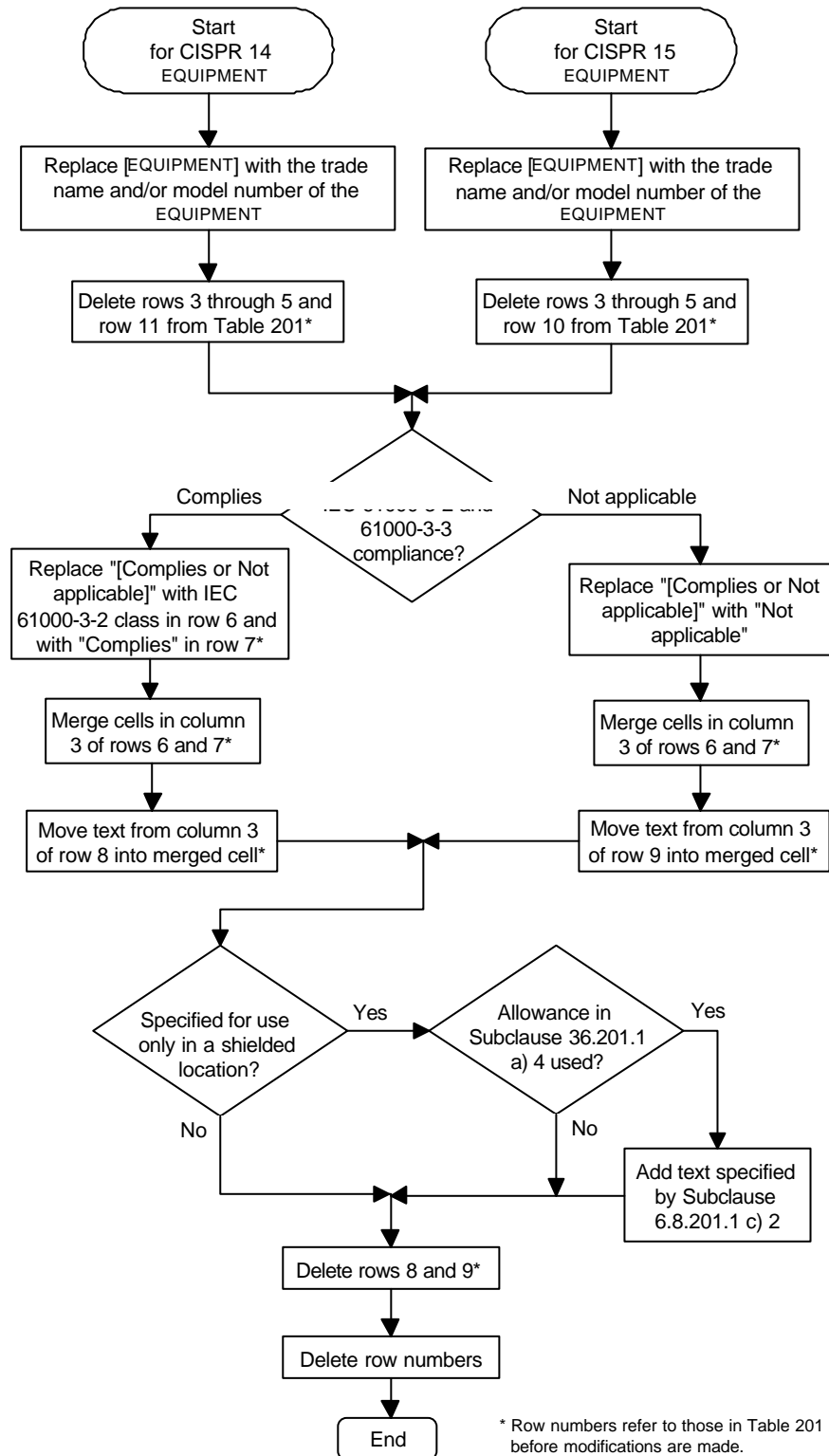

Figure 201b
Instructions for completing Table 201
For CISPR 14 and CISPR 15 EQUIPMENT
(See Subclause 6.8.201.1 a) 3.)

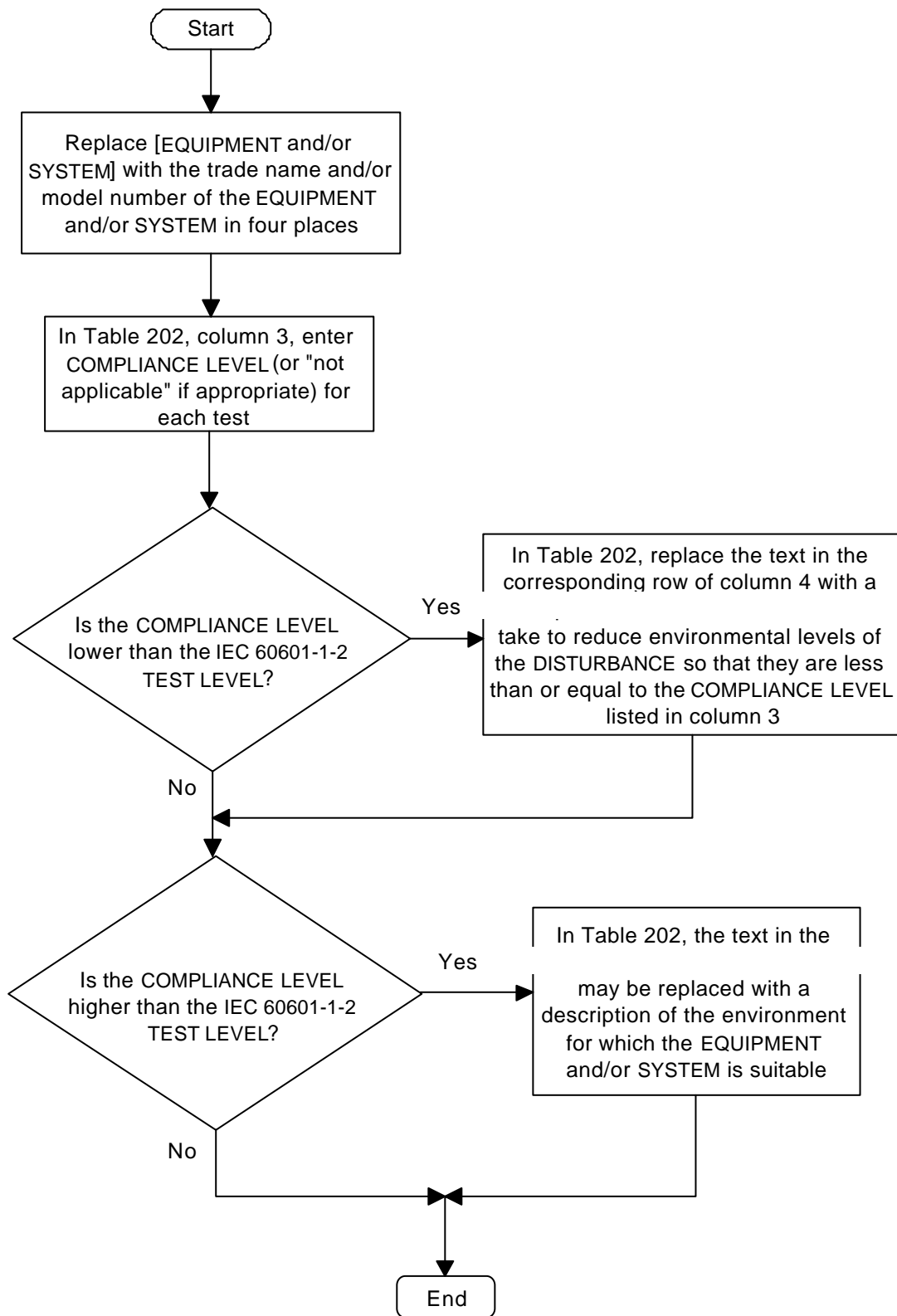

Figure 202

**Instructions for completing Table 202
(See Subclause 6.8.201.1 a) 6.)**

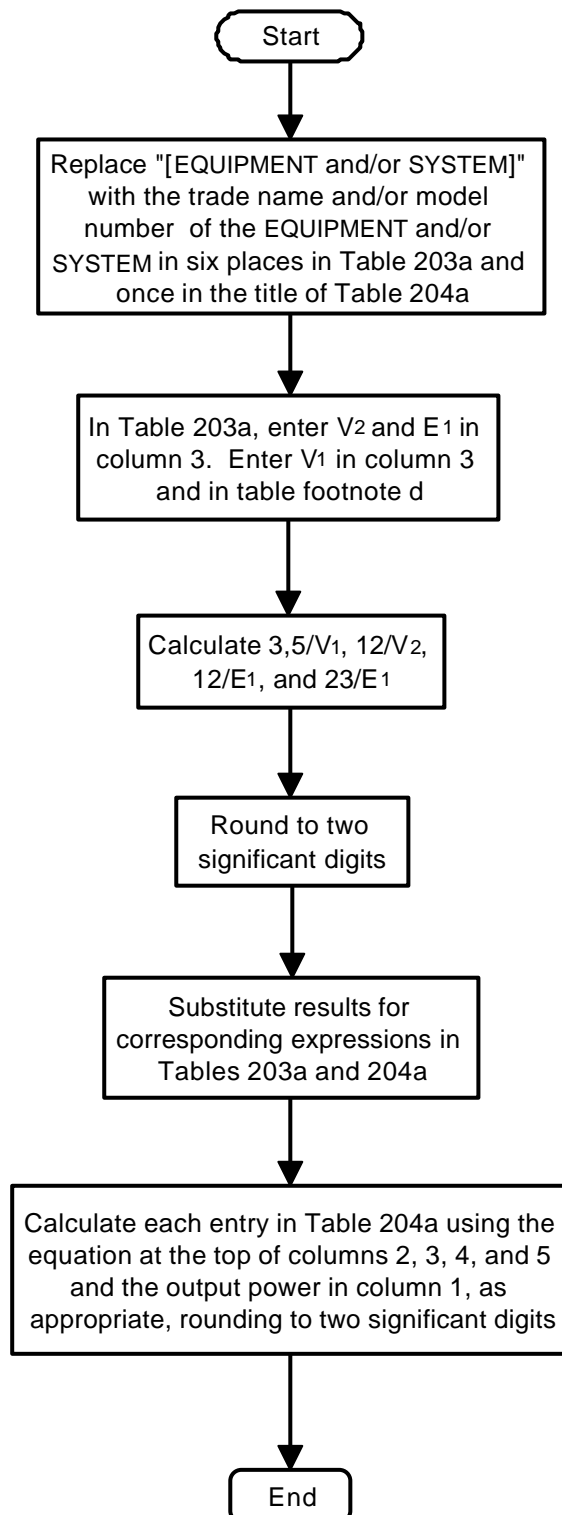

Figure 203a
Instructions for completing Tables 203a and 204a
For LIFE-SUPPORTING EQUIPMENT and/or SYSTEMS

(See Subclause 6.8.201.1 b.)

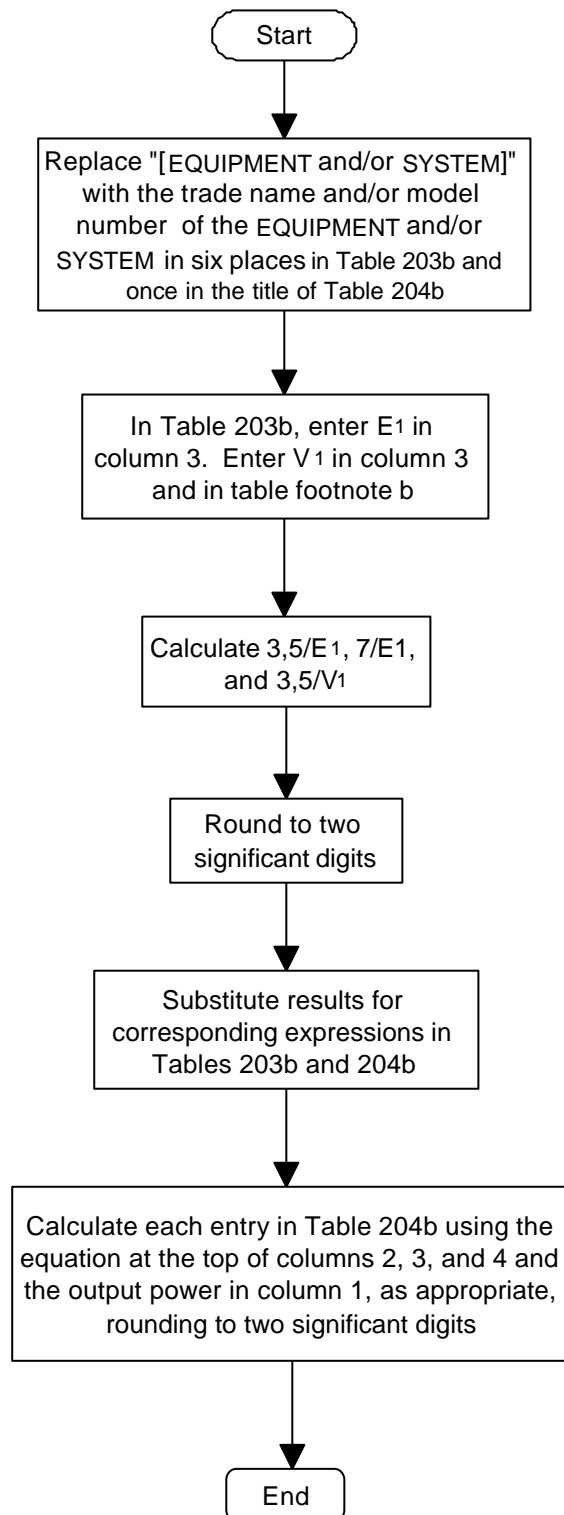

Figure 203b
Instructions for completing Tables 203b and 204b
For EQUIPMENT and/or SYSTEMS that are not LIFE-SUPPORTING

(See Subclause 6.8.201.1 b.)

SECTION 5: PROTECTION AGAINST HAZARDS FROM UNWANTED OR EXCESSIVE RADIATION

36 ELECTROMAGNETIC COMPATIBILITY

36.201 EMISSIONS

36.201.1 Protection of radio services

*a) Requirements

EQUIPMENT and/or SYSTEMS, except as specified in items 1 through 3 below, shall be classified as Group 1 or Group 2 and Class A or Class B in accordance with CISPR 11, based on their intended use, as specified by the manufacturer, using the guidelines in Annex CCC. EQUIPMENT and/or SYSTEMS shall comply with CISPR requirements, based upon their classification, with the exceptions and clarifications specified in items 4 and 5 below.

*1. Simple electrical components

MEDICAL ELECTRICAL EQUIPMENT containing only simple electrical components like motors and switches and not utilizing any electronic circuitry that generates and/or uses frequencies above 9 kHz (e.g. some dental drills, some ventilators, some operating tables) may be classified in accordance with CISPR 14. Classification to CISPR 14, however, is limited to stand-alone EQUIPMENT and is not applicable to SYSTEMS and/or sub-SYSTEMS.

2. Lighting equipment

Lighting equipment used in medical applications (e.g. equipment for illumination of x-ray films, lighting devices for operating theatres) may be classified in accordance with CISPR 15. Classification to CISPR 15, however, is limited to stand-alone EQUIPMENT and is not applicable to SYSTEMS and/or sub-SYSTEMS.

*3. INFORMATION TECHNOLOGY EQUIPMENT (ITE)

ITE connected to EQUIPMENT and/or SYSTEMS may be classified in accordance with CISPR 22 with the following restriction: CISPR 22 Class B equipment may be used with CISPR 11 Class A or Class B SYSTEMS, but CISPR 22 Class A equipment may only be used with CISPR 11 Class A SYSTEMS.⁷

⁷ See Annex CCC.

*4. EQUIPMENT and/or SYSTEMS specified for use only in a shielded location

- For EQUIPMENT and/or SYSTEMS that are specified for use only in a shielded location, the electromagnetic radiation disturbance limits in each frequency band for which CISPR 11 specifies limits may be increased, when tests are performed on a test site, by an amount up to the specified minimum RF shielding effectiveness of the shielded location. This allowance is only applicable if the minimum shielding effectiveness is specified to be at least 20 dB over the frequency band 150 kHz to 2,5 GHz.
- For EQUIPMENT and/or SYSTEMS that are specified for use only in a shielded location, the mains terminal disturbance voltage limits in each frequency band for which CISPR 11 specifies limits may be increased, when tests are performed on a test site, by an amount up to the specified minimum RF filter attenuation for all cables that exit the shielded location. This allowance is only applicable if the minimum filter attenuation is specified to be at least 20 dB over the frequency band 150 kHz to 2,5 GHz.

5. EQUIPMENT and/or SYSTEMS that include RF transmitters

EQUIPMENT and/or SYSTEMS including RF transmitters that comply with the requirements of the ITU and/or national and/or regional authorities are exempt from the requirements of CISPR 11 in the dedicated transmission band of the transmitter. EQUIPMENT and/or SYSTEMS including RF transmitters that comply with the requirements of the ITU and/or national and/or regional authorities are also exempt from testing in accordance with the electromagnetic radiation disturbance requirements of CISPR 11 outside the dedicated transmission band of the transmitter, provided the EMISSIONS limits of the ITU and/or national and/or regional authorities are less than or equal to the applicable CISPR 11 electromagnetic radiation disturbance limits.

6. Documentation of the test

The documentation of the test shall include the test methods used to verify compliance with the requirements of this subclause. Specifically, this documentation shall include a description of the EQUIPMENT and/or SYSTEM under test, test equipment and test set-up, settings and mode(s) of the EQUIPMENT and/or SYSTEM, cable layout, and all PATIENT physiological, ACCESSORY, and/or sub-SYSTEM simulators used.

Compliance is checked by the following tests:

b) *Tests*

CISPR test methods shall be used, with the clarifications and exceptions specified in items 1 and 2 below.

**1. PATIENT cables*

PATIENT-coupled cables shall be considered interconnecting cables in accordance with the requirements of CISPR 11. Any PATIENT-coupled cable termination used shall be described in the test documentation. If simulated PATIENT physiological signals are required to simulate normal operation of the EQUIPMENT and/or SYSTEM, they shall be provided. The PATIENT coupling point shall not have an intentional conductive and/or capacitive connection to ground during testing. Unintentional capacitance between the PATIENT coupling point and ground should be no greater than 250 pF.

**2. Sub-SYSTEMS*

Compliance with the requirements of CISPR 11 may be demonstrated by testing each sub-SYSTEM of a SYSTEM, provided that normal operating conditions are simulated.

When EQUIPMENT is being evaluated that interacts with other EQUIPMENT to form a SYSTEM, then the evaluation may be carried out using either additional EQUIPMENT to represent the total SYSTEM or with the use of simulators.

3. LARGE, PERMANENTLY-INSTALLED EQUIPMENT and/or SYSTEMS

LARGE, PERMANENTLY-INSTALLED EQUIPMENT and/or SYSTEMS that are constructed in such a way that simulated operation of sub-SYSTEMS is not feasible may be type tested at the premises of a typical user in accordance with CISPR 11 Clause 5, Limits of electromagnetic disturbances, and 11.2, Equipment in small-scale production.

36.201.2 Protection of other equipment

***36.201.2.1 Low frequency magnetic fields**

No requirements apply

36.201.3 Protection of the PUBLIC MAINS NETWORK

36.201.3.1 Harmonic distortion

*a) Requirements

EQUIPMENT and/or SYSTEMS with a RATED input current up to and including 16 A per phase and that are intended to be connected to the PUBLIC MAINS NETWORK shall comply with the requirements of IEC 61000-3-2. If an EQUIPMENT and/or SYSTEM has both long-time and momentary current ratings, the higher of the two ratings shall be used in determining the applicability of IEC 61000-3-2.

Compliance is checked by the following tests:

b) Tests

The test methods and test equipment specified by IEC 61000-3-2 shall apply.

36.201.3.2 Voltage fluctuations and flicker

*a) Requirements

EQUIPMENT and/or SYSTEMS with a RATED input current up to and including 16 A per phase and that are intended to be connected to the PUBLIC MAINS NETWORK shall comply with the requirements of IEC 61000-3-3. If an EQUIPMENT and/or SYSTEM has both long-time and momentary current ratings, the higher of the two ratings shall be used in determining the applicability of IEC 61000-3-3.

Compliance is checked by the following tests:

b) Tests

The test methods and test equipment specified by IEC 61000-3-3 shall apply.

36.202 IMMUNITY

*36.202.1 General

*a) IEC 60601-1-2 TEST LEVELS

Subclause 36.202, *IMMUNITY*, specifies IMMUNITY requirements that are appropriate for EQUIPMENT and/or SYSTEMS intended for use in a typical health care ELECTROMAGNETIC ENVIRONMENT.⁸ Until limits are developed for other environments, the requirements of Subclause 36.202, *IMMUNITY*, shall apply to EQUIPMENT and/or SYSTEMS used in all environments. Lower IMMUNITY COMPLIANCE LEVELS are allowed,⁹ provided they can be justified based on significant physical, technological and/or physiological limitations (see Subclause

⁸ For information concerning electromagnetic environments, refer to Annexes EEE and GGG.

⁹ The allowance for lower levels should be removed in Particular Standards. See Annex DDD, Subclause DDD2 a) for guidance.

6.8.201.1 a) 5).

b) Documentation of the test

The documentation of the test shall include the test methods used to verify compliance with the requirements of this subclause. Specifically, this documentation shall include a description of the EQUIPMENT and/or SYSTEM under test, details of the compliance criteria used, test equipment and test set-up, settings and mode(s) of the EQUIPMENT and/or SYSTEM, cable layout, and all PATIENT physiological, ACCESSORY, and/or sub-SYSTEM simulators used.

*c) Operating mode and configuration

During IMMUNITY testing, each CRITICAL FUNCTION of the EQUIPMENT and/or SYSTEM shall be tested in the mode that is most critical from a PATIENT outcome perspective, based upon a risk analysis, using equipment options, cable layout and ACCESSORIES in a typical configuration, consistent with NORMAL USE. This risk analysis is not required if all modes of the EQUIPMENT and/or SYSTEM are tested. If the EQUIPMENT and/or SYSTEM is not RATED for continuous duty, the operating mode may instead be selected such that reliable operation is obtained for the applicable test duration.

*d) Non-medical equipment

Non-medical equipment that is supplied as part of a SYSTEM and the use of which in the SYSTEM can be reasonably expected not to affect the CRITICAL FUNCTIONS of the SYSTEM if the non-medical equipment exhibits DEGRADATION, is exempt from the IMMUNITY testing requirements of this standard, provided the non-medical equipment complies with applicable international IMMUNITY standards. The determination of reasonable expectation not to affect the CRITICAL FUNCTIONS of the SYSTEM shall be based upon a risk analysis. This risk analysis is not required if the non-medical equipment supplied as part of a SYSTEM is tested for IMMUNITY in accordance with Subclause 36.202, *IMMUNITY*.

*e) PATIENT-COUPLED EQUIPMENT and/or SYSTEMS

PATIENT-COUPLED EQUIPMENT and/or SYSTEMS shall be tested so that the PATIENT coupling point is within the test environment. The PATIENT coupling point shall not have an intentional conductive and/or capacitive connection to ground during testing, except as otherwise specified in a subclause of this standard. Unintentional capacitance between the PATIENT coupling point and ground should be no greater than 250 pF.

*f) Variable gain

EQUIPMENT and/or SYSTEMS that incorporate a variable gain shall be tested at the highest gain setting that allows proper operation.

If this requirement can be met with the EQUIPMENT and/or SYSTEM's normal software, the test shall be performed using the normal software. If this requirement cannot be met using the EQUIPMENT and/or SYSTEM's normal software, a method shall be provided to implement this operational mode. The use of special software may be required. If special software is used, it shall not inhibit changes in gain that may occur as a result of testing.

*g) PATIENT simulation

If simulated PATIENT physiological signals are required to verify normal operation of the EQUIPMENT and/or SYSTEM, they shall be provided. The simulator used shall not provide an intentional conductive and/or capacitive connection to ground during testing, except as otherwise specified in a subclause of this standard. Unintentional capacitance between the PATIENT coupling point and ground should be no greater than 250 pF. Prior to the beginning of the test, the simulated signal shall be adjusted as follows:

- For EQUIPMENT and/or SYSTEMS without a manual sensitivity adjustment, the simulated PATIENT physiological signal shall be set to the lowest amplitude and/or value consistent with normal operation as specified by the manufacturer. If this minimum amplitude and/or value is specified by the manufacturer, it shall be included in the *Instructions for use* as specified in Subclause 6.8.201.2 c), *Minimum amplitude and/or value of PATIENT physiological signal*. If the lowest amplitude and/or value consistent with normal operation is not specified by the manufacturer, then the simulated PATIENT physiological signal shall be set to the minimum amplitude and/or value at which the EQUIPMENT and/or SYSTEM operates as intended.
- For EQUIPMENT and/or SYSTEMS with a manual sensitivity adjustment, the simulated PATIENT physiological signal shall be set according to the manufacturer's sensitivity adjustment guidelines with the EQUIPMENT and/or SYSTEM operating at its most sensitive setting.

If simulated PATIENT physiological signals are not required to verify normal operation of the EQUIPMENT and/or SYSTEM, the EQUIPMENT and/or SYSTEM shall be tested as specified in Subclause 36.202.1 c), *Operating mode and configuration*, without PATIENT physiological signal simulation.

*h) Testing of normally non-observable CRITICAL FUNCTIONS

If the operation of a CRITICAL FUNCTION (e.g. a critical alarm) cannot normally be observed or verified during the test, a method shall be provided (e.g. display of internal parameters) for determining compliance. The use of special software and/or hardware may be required.

*i) Sub-SYSTEMS

Compliance with the requirements of this standard may be demonstrated by testing each sub-SYSTEM of a SYSTEM, provided that normal operating conditions are simulated.

When an EQUIPMENT is being evaluated that interacts with other EQUIPMENT to form a SYSTEM, then the evaluation may be carried out using either additional EQUIPMENT to represent the total SYSTEM or with the use of simulators.

*j) Compliance criteria

Under the test conditions specified in Subclause 36.202, *IMMUNITY*, the EQUIPMENT and/or SYSTEM shall be able to provide the intended clinical benefit and remain safe. The EQUIPMENT and/or SYSTEM may exhibit DEGRADATION of performance (e.g. deviation from manufacturer's specifications). However, the following DEGRADATIONS shall not be allowed:

- component failures
- changes in programmable parameters
- reset to factory defaults (manufacturer's presets)
- change of operating mode
- false alarms
- cessation of any intended operation, even if accompanied by an alarm
- initiation of any unintended operation, including unintended or uncontrolled motion, even if accompanied by an alarm
- error of a displayed numerical value sufficiently large to affect diagnosis or treatment
- noise on a waveform in which the noise is indistinguishable from physiologically-produced signals or the noise interferes with interpretation of physiologically-produced signals
- artefact or distortion in an image in which the artefact is indistinguishable from physiologically-produced signals or the distortion interferes with interpretation of physiologically-produced signals
- failure of automatic diagnosis or treatment EQUIPMENT and/or SYSTEMS to diagnose or treat, even if accompanied by an alarm

For EQUIPMENT and/or SYSTEMS with multiple FUNCTIONS, the criteria apply to

each FUNCTION, parameter and/or channel.

36.202.2 Electrostatic discharge (ESD)

*a) Requirements

EQUIPMENT and/or SYSTEMS shall comply with the requirements of Subclause 36.202.1 j), *Compliance criteria*, at IMMUNITY TEST LEVELS of ± 2 kV, ± 4 kV and ± 8 kV for air discharge and ± 2 kV, ± 4 kV and ± 6 kV for contact discharge.

Compliance is checked by the following tests and determined in accordance with Subclause 36.202.1 j), Compliance criteria, based upon the response of the EQUIPMENT and/or SYSTEM, considering each discharge individually:

b) Tests

The test method and equipment specified by IEC 61000-4-2 apply with the following modifications:

- *1. The time between discharges shall have an initial value of 1 s. Longer time between discharges may be required in order to be able to distinguish between a response caused by a single discharge and a response caused by a number of discharges.*
- *2. Contact discharges shall be applied to conductive ACCESSIBLE PARTS of the EQUIPMENT and/or SYSTEM and coupling planes.*
- *3. Air discharges shall be applied to non-conductive ACCESSIBLE PARTS of the EQUIPMENT and/or SYSTEM and conductive non-accessible portions of ACCESSIBLE PARTS. If the EQUIPMENT and/or SYSTEM is labelled with the IEC 60417-5134 symbol adjacent to a connector, that connector is exempt from this testing. (See Subclause 6.1.201.2, Marking on the outside of EQUIPMENT or EQUIPMENT parts for which the connector testing exemption specified in Subclause 36.202.2 b) 3 is used, and Subclause 6.8.201.2 b), Requirements applicable to EQUIPMENT and/or SYSTEMS for which the connector testing exemption specified in Subclause 36.202.2 b) 3 is used.*
- *4. EQUIPMENT and/or SYSTEMS that are internally powered, CLASS II or contain circuitry isolated from protective earth shall be tested in such a way as to ensure that there is no appreciable charge retention between individual test discharges. The potential on the EQUIPMENT and/or SYSTEM may be equalized with that of the ground plane, between individual test discharges, by temporarily grounding it through two 470 kW resistors connected in series. This potential equalization connection shall be*

disconnected and moved away from the EQUIPMENT and/or SYSTEM during application of a test discharge.

5. *The test may be performed with the EQUIPMENT and/or SYSTEM powered at any one of its nominal input voltages and frequencies.*

36.202.3 Radiated RF electromagnetic fields

a) Requirements

- *1. EQUIPMENT and/or SYSTEMS that are not LIFE-SUPPORTING

EQUIPMENT and/or SYSTEMS that are not LIFE-SUPPORTING EQUIPMENT and/or SYSTEMS except as specified in 3 below or in the EXCLUSION BAND as specified in 4 below shall comply with the requirements of Subclause 36.202.1 j), *Compliance criteria*, at an IMMUNITY TEST LEVEL of 3 V/m over the frequency range 80 MHz to 2,5 GHz.

- *2. LIFE-SUPPORTING EQUIPMENT and/or SYSTEMS

LIFE-SUPPORTING EQUIPMENT and/or SYSTEMS except as specified in 3 below or within the EXCLUSION BAND as specified in 4 below shall comply with the requirements of Subclause 36.202.1 j), *Compliance criteria*, at an IMMUNITY TEST LEVEL of 10 V/m over the frequency range 80 MHz to 2,5 GHz.

- *3. EQUIPMENT and/or SYSTEMS specified for use only in a shielded location

EQUIPMENT and/or SYSTEMS specified for use only in a shielded location, except within the EXCLUSION BAND as specified in 4 below, may comply with the requirements of Subclause 36.202.1 j), *Compliance criteria*, at an IMMUNITY TEST LEVEL that is reduced from the test level specified in 1 or 2 above, as applicable, in proportion to the specified minimum RF shielding effectiveness / filter attenuation of the shielded location over the frequency range 150 kHz to 2,5 GHz, determined as specified in Subclause 6.8.201.1 c) 2. This allowance is only applicable if the minimum RF filter attenuation for each cable entering the shielded location and the minimum RF shielding effectiveness are specified to be at least 20 dB over the frequency range 150 kHz to 2,5 GHz.

- *4. EQUIPMENT and/or SYSTEMS that include receivers of RF electromagnetic energy

EQUIPMENT and/or SYSTEMS that intentionally receive RF electromagnetic energy for the purpose of their operation are exempt from the requirements of Subclause 36.202.3, *Radiated RF electromagnetic fields*, in the

EXCLUSION BAND; however, in the EXCLUSION BAND, the EQUIPMENT and/or SYSTEM shall remain safe and the other FUNCTIONS of the EQUIPMENT and/or SYSTEM shall comply with the requirements specified in 1 or 2 above, as applicable. EQUIPMENT and/or SYSTEMS shall comply with the requirements specified in 1 or 2 above, as applicable, outside of the EXCLUSION BAND.

Compliance is checked by the following tests and determined during and after the tests in accordance with Subclause 36.202.1 j), Compliance criteria:

b) Tests

The test method and equipment specified by IEC 61000-4-3 apply with the following additions and modifications:

1. *The test frequency shall be swept or stepped from 80 MHz to 2,5 GHz.*
2. *The uniform field calibration steps specified in Subclause 6.2 h) of IEC 61000-4-3 shall be no greater than 1 % of the fundamental frequency.*
- *3. *The test signal shall be 80 % amplitude modulated at the modulation frequency that is specified in Table 206, based upon the intended use of the EQUIPMENT and/or SYSTEM. (Unmodulated and modulated waveforms normalized to a generator output of 1,0 Vrms are shown in Figure 1 of IEC 61000-4-3). For EQUIPMENT and/or SYSTEMS for which testing at 2 Hz is required, it is not necessary to additionally test at 1 kHz. For EQUIPMENT and/or SYSTEMS intended to monitor or measure a physiological parameter, the PHYSIOLOGICAL SIMULATION FREQUENCY restrictions specified in Table 206 shall apply. For EQUIPMENT and/or SYSTEMS intended to control a physiological parameter, the OPERATING FREQUENCY restrictions specified in Table 206 shall apply.*

Intended Use	Modulation Frequency	PHYSIOLOGICAL SIMULATION FREQUENCY and OPERATING FREQUENCY
Control, monitor or measure a physiological parameter	2 Hz	Less than 1 Hz or greater than 3 Hz
All other	1 kHz	Not applicable

Table 206
Modulation frequency, PHYSIOLOGICAL SIMULATION FREQUENCY, and OPERATING FREQUENCY

- *4. For the frequency step and dwell method (Clause 8, Test procedures, of IEC 61000-4-3):

The minimum dwell time shall be based upon the time required for the EQUIPMENT and/or SYSTEM to be exercised (if applicable) and adequately respond to the test signal. The dwell time shall be at least 3 s for EQUIPMENT and/or SYSTEMS tested with a 2 Hz modulation frequency and 1 s for all other EQUIPMENT and/or SYSTEMS and shall be no less than the response time of the slowest responding FUNCTION plus the settling time of the radiated RF IMMUNITY test system. For EQUIPMENT and/or SYSTEMS that average data over time for which faster-responding signals cannot be used to determine the effect of the test signal on the EQUIPMENT and/or SYSTEM, the dwell time shall be no less than 1,2 times the averaging period. If the averaging period is adjustable, the averaging period used to determine dwell time shall be that which is expected to be used most often in clinical application of the EQUIPMENT and/or SYSTEM. For EQUIPMENT and/or SYSTEMS for which faster-responding signals can be used to determine the effect of the test signal on the EQUIPMENT and/or SYSTEM, the dwell time may be reduced if the faster-responding signals are monitored. In this case, the dwell time shall be no less than the response time of the signal or of the monitoring system, whichever is greater, plus the response time of the radiated RF IMMUNITY test system, but in no case less than 3 s for EQUIPMENT and/or SYSTEMS tested with a 2 Hz modulation frequency and 1 s for all other EQUIPMENT and/or SYSTEMS. For EQUIPMENT and/or SYSTEMS that have multiple individual parameters or sub-SYSTEMS, each of which would yield a different dwell time, the value used shall be the maximum of the individually-determined dwell times.

The frequency step size shall not exceed 1 % of the fundamental. (The next test frequency is less than or equal to the previous test frequency times 1,01.)

- *5. For the continuous frequency sweep method (Clause 8, Test procedures, of IEC 61000-4-3):

The rate of sweep shall not be greater than $(4,5/X) \times 10^{-3}$ decades/s where X is the dwell time in seconds determined from 4 above (the dwell time specified above for the frequency step and dwell method using a 1 % step size).

6. *Objects other than the EQUIPMENT and/or SYSTEM and necessary simulation equipment shall not be introduced into the test area or between the field generating antenna and the location of the EQUIPMENT and/or SYSTEM during the uniform field calibration and during the test. Necessary*

simulation equipment shall as much as possible be selected and located to minimize disruption of the uniform field. Special care shall be taken with monitoring equipment used to determine performance, such as cameras and conductive connections to the EQUIPMENT and/or SYSTEM.

7. *Test conditions for EQUIPMENT and/or SYSTEMS with a receiving section for RF electromagnetic energy:*

The receiving section of the EQUIPMENT and/or SYSTEM shall be tuned to the preferred frequency of reception. If the receiving section of the EQUIPMENT and/or SYSTEM has no preferred frequency of reception, the receiving section of the EQUIPMENT and/or SYSTEM shall be tuned to the centre of the frequency range from which the frequency of reception can be selected.

- *8. *PATIENT-coupled cables used during the test shall be the longest allowed by the manufacturer, as specified in the ACCOMPANYING DOCUMENTS. The PATIENT coupling point shall not have an intentional conductive and/or capacitive connection to ground, including through the PATIENT physiological signal simulation, if used. Unintentional capacitance between the PATIENT coupling point and ground should be no greater than 250 pF. The interface between the PATIENT physiological signal simulation, if used, and the EQUIPMENT and/or SYSTEM shall be located within 0,10 m of the vertical plane of the uniform field area in one orientation of the EQUIPMENT and/or SYSTEM.¹⁰*
- *9. *LARGE, PERMANENTLY-INSTALLED EQUIPMENT and/or SYSTEMS that are constructed in such a way that simulated operation of sub-SYSTEMS is not feasible are exempt from the testing requirements specified by IEC 61000-4-3. If this exemption is used, such LARGE, PERMANENTLY-INSTALLED EQUIPMENT and/or SYSTEMS shall be type tested either at one installation site or on an open area test site, using the ambient RF sources (e.g. radio (cellular/cordless) telephones, walkie talkies, other legal transmitters) that occur in a typical health care environment. In addition, testing shall be performed in the range 80 MHz to 2,5 GHz at frequencies designated by the ITU for ISM use. The power of, and/or distance from, the source shall be adjusted to provide the applicable test level specified in a) above, with the exception that the actual modulations may be used (e.g. for radio (cellular/cordless) telephones, walkie talkies). This testing allowance does not affect the requirements specified in Subclause 36.202.6, Conducted disturbances, induced by RF fields. (See also Subclause 6.8.201.1 h.)*

¹⁰ See Annex AAA, Figure AAA201, for an example cable arrangement.

10. *The test may be performed with the EQUIPMENT and/or SYSTEM powered at any one of its nominal input voltages and frequencies.*

36.202.4 Electrical fast transients and bursts

***a) Requirements**

EQUIPMENT and/or SYSTEMS shall comply with the requirements of Subclause 36.202.1 j), *Compliance criteria*, at an IMMUNITY TEST LEVEL of ± 2 kV on a.c. and d.c. power lines and ± 1 kV for signal and interconnecting cables. Signal and interconnecting cables specified to be (i.e. restricted to) less than 3 m in length by the manufacturer of the EQUIPMENT and/or SYSTEM and all PATIENT-coupled cables are not tested directly. However, the effects of any coupling between cables that are tested directly and cables that are not tested directly shall be taken into account.

Compliance is checked by the following tests and determined during and after the tests in accordance with Subclause 36.202.1 j), Compliance criteria:

b) Tests

The test method and equipment specified by IEC 61000-4-4 shall apply with the following modifications:

1. *PATIENT-coupled cables of EQUIPMENT and/or SYSTEMS are not tested directly, but shall be attached during the testing of power lines and of all other cables that are tested. The entire length of PATIENT-coupled cables, including the PATIENT coupling point, shall be within the test environment. As much as possible, PATIENT-coupled cables shall be arranged as in NORMAL USE. They shall not be arranged so that coupling to them from cables that are tested directly is greater than the coupling that would be expected in NORMAL USE.*
2. *For internally-powered EQUIPMENT and/or SYSTEMS without the option of a.c. or d.c. power inputs, all cables are tested except PATIENT-coupled cables and signal and interconnecting cables specified to be less than 3 m in length. If such an EQUIPMENT and/or SYSTEM has only PATIENT-coupled cables and signal and interconnecting cables specified to be less than 3 m in length, this test does not apply.*
- *3. *PATIENT-coupled parts of EQUIPMENT and/or SYSTEMS shall be terminated as specified below during the test to properly simulate the capacitive coupling effect of the PATIENT.*
 - *For PATIENT coupling points that do not have a conductive contact, the*

PATIENT coupling point shall be terminated with the artificial hand specified in CISPR 16-1. The metal foil of the artificial hand shall be applied to simulate the capacitive coupling effect of the PATIENT. The metal foil of the artificial hand shall be connected to the M terminal of the RC element of the artificial hand, and the other terminal of the RC element shall be connected to the ground reference plane.

- *For PATIENT coupling points that have conductive contact to the PATIENT, the M terminal of the RC element of the artificial hand (see CISPR 16-1) shall be connected directly to the conductive PATIENT connection, and the other terminal of the RC element shall be connected to the ground reference plane. If normal operation of the EQUIPMENT and/or SYSTEM cannot be verified with the M terminal of the artificial hand connected to the coupling point, an insulating material with a thickness of 5 mm or less may be applied between the metal foil of the artificial hand (see CISPR 16-1) and the PATIENT coupling point. In this case, the metal foil of the artificial hand shall be applied to simulate the capacitive coupling effect of the PATIENT and the M terminal of the RC element of the artificial hand shall be connected to the metal foil but not to the PATIENT coupling point. The other terminal of the RC element shall be connected to the ground reference plane.*
- *- *For EQUIPMENT and/or SYSTEMS that have multiple PATIENT coupling points or multiple PATIENT-coupled parts, each PATIENT coupling point and each PATIENT-coupled part shall have an artificial hand applied as specified above, with the exception that the combined resistance and capacitance between the EQUIPMENT and/or SYSTEM and the ground reference plane, due to all applied artificial hands simulating the capacitive coupling effect of the PATIENT, shall be $510\ \Omega \pm 10\%$ in series with $220\ \text{pF} \pm 20\%$.*
- *4. *HAND-HELD EQUIPMENT and/or parts of EQUIPMENT intended to be hand-held during NORMAL USE shall be tested with an artificial hand applied as specified in CISPR 16-1, to simulate the capacitive coupling effect of the OPERATOR. The artificial hand shall be connected to the ground reference plane.*
- 5. *For EQUIPMENT and/or SYSTEMS that have, for power input, multiple voltage settings or autoranging voltage capability, the test shall be performed at the minimum and maximum RATED input voltages. The test may be performed with the EQUIPMENT and/or SYSTEM powered at any one of its nominal power frequencies.*

36.202.5 Surges

*a) Requirements

The EQUIPMENT and/or SYSTEM shall comply with the requirements of Subclause 36.202.1 j), *Compliance criteria*, at IMMUNITY TEST LEVELS of $\pm 0,5$ kV; ± 1 kV and ± 2 kV for a.c. power line(s) to ground and $\pm 0,5$ kV and ± 1 kV for a.c. power line(s) to lines(s). All other EQUIPMENT and/or SYSTEM cables are not tested directly. The determination of compliance with this requirement shall be based on the response of the EQUIPMENT and/or SYSTEM, considering each surge individually, taking into account the effects of any coupling between cables that are tested directly and cables that are not tested directly.

Compliance is checked by the following tests and determined during and after the tests in accordance with Subclause 36.202.1 j), Compliance criteria:

*b) Tests

The test method and equipment specified by IEC 61000-4-5 for the combination wave test shall apply with the following modifications:

1. *Only power lines and a.c. inputs to a.c.-to-d.c. converters and battery chargers are tested; however, all EQUIPMENT and/or SYSTEM cables shall be attached during the test.*
2. *Five surges at each voltage level and polarity shall be applied to each power line at each of the following a.c. voltage waveform angles: 0, 90, and 270 degrees.*
- *3. *EQUIPMENT and/or SYSTEMS that do not have a surge protection device in the primary power circuit may be tested only at ± 2 kV line(s) to ground and ± 1 kV line(s) to line(s). However, in case of dispute, the EQUIPMENT and/or SYSTEM shall comply at all the IMMUNITY TEST LEVELS specified in 36.202.5 a).*
- *4. *Class II EQUIPMENT and/or SYSTEMS without any grounded interconnections are exempt from line(s) to ground testing.*
5. *For internally-powered EQUIPMENT and/or SYSTEMS without the option of a.c. or d.c. power inputs, this test does not apply.*
6. *For EQUIPMENT and/or SYSTEMS that have, for power input, multiple voltage settings or autoranging voltage capability, the test shall be performed at the minimum and maximum RATED input voltages. The test may be performed with the EQUIPMENT and/or SYSTEM powered at any one of its nominal power frequencies.*

36.202.6 Conducted disturbances, induced by RF fields

a) Requirements

*1. EQUIPMENT and/or SYSTEMS that are not LIFE-SUPPORTING

EQUIPMENT and/or SYSTEMS that are not LIFE-SUPPORTING, except as defined in 3, 4, and/or 5 below, shall comply with the requirements of Subclause 36.202.1 j), *Compliance criteria*, at an IMMUNITY TEST LEVEL of 3 Vrms over the frequency range beginning at the start frequency determined as specified in 6 below and extending to 80 MHz.

*2. LIFE-SUPPORTING EQUIPMENT and/or SYSTEMS

LIFE-SUPPORTING EQUIPMENT and/or SYSTEMS, except as defined in 3, 4, and/or 5 below, shall comply with the requirements of Subclause 36.202.1 j), *Compliance criteria*, at an IMMUNITY TEST LEVEL of 3 Vrms over the frequency range beginning at the start frequency determined as specified in 6 below and extending to 80 MHz, and 10 Vrms in the industrial, scientific and medical (ISM) frequency bands between the start frequency and 80 MHz.

*3. EQUIPMENT and/or SYSTEMS specified for use only in a shielded location

EQUIPMENT and/or SYSTEMS specified for use only in a shielded location, except within the EXCLUSION BAND as specified in 4 below, may comply with the requirements of Subclause 36.202.1 j), *Compliance criteria*, at an IMMUNITY TEST LEVEL that is reduced from the test level specified in 1 or 2 above, as applicable, in proportion to the specified minimum RF shielding effectiveness / filter attenuation of the shielded location over the frequency range 150 kHz to 2,5 GHz, determined as specified in Subclause 6.8.201.1 c) 2. This allowance is only applicable if the minimum RF filter attenuation for each cable entering the shielded location and the minimum RF shielding effectiveness are specified to be at least 20 dB over the frequency range 150 kHz to 2,5 GHz.

*4. EQUIPMENT and/or SYSTEMS that intentionally receive RF electromagnetic energy

EQUIPMENT and/or SYSTEMS that intentionally receive RF electromagnetic energy for the purpose of their operation are exempt from the requirements of Subclause 36.202.6, *Conducted disturbances, induced by RF fields*, in the EXCLUSION BAND; however, in the EXCLUSION BAND, the EQUIPMENT and/or SYSTEM shall remain safe and the other FUNCTIONS of the EQUIPMENT and/or SYSTEM shall comply with the requirements specified in 1 or 2 above, as

applicable. EQUIPMENT and/or SYSTEMS shall comply with the requirements specified in 1 or 2 above, as applicable, outside of the EXCLUSION BAND.

*5. Battery-powered EQUIPMENT

Battery-powered EQUIPMENT that cannot be used during battery charging; is less than 1 m maximum dimension including the maximum length of all cables connected;¹¹ and has no connection to ground, telecommunications systems, any other EQUIPMENT and/or SYSTEM or a PATIENT are exempt from the requirements of Subclause 36.202.6, *Conducted disturbances, induced by RF fields*.

6. Start frequency

The start frequency (lower end of the test frequency range) used for testing each cable of the EQUIPMENT and/or SYSTEM shall be determined as follows:

- For battery-powered EQUIPMENT and/or SYSTEMS that cannot be used during battery charging, do not have an option for a.c. power input, and have no connection to ground, telecommunications systems, any other EQUIPMENT and/or SYSTEM or a PATIENT, the start frequency shall be determined from Figure B.1 in IEC 61000-4-6 Annex B, *Selection criteria for the frequency range of application*, using the maximum dimension of the EQUIPMENT and/or SYSTEM, including the maximum length of each cable connected.¹²
- For all other EQUIPMENT and/or SYSTEMS, the start frequency shall be 150 kHz.

Compliance is checked by the following tests and determined during and after the tests in accordance with Subclause 36.202.1 j), Compliance criteria:

b) Tests

The method and equipment specified by IEC 61000-4-6 shall apply with the following modifications:

1. *The following provisions of IEC 61000-4-6 are modified or clarified:*

- *- *The terms "direct injection" and "injection using a coupling and decoupling network" are used throughout IEC 61000-4-6. In that standard, "direct injection" means that no capacitors are used in the injection circuit. The term "CDN" is used in this standard to indicate*

¹¹ See Annex AAA, Figure AAA202, for guidance on determination of the maximum dimension.

¹² See Annex AAA, Figure AAA202, for guidance on determination of the maximum dimension.

the network that is appropriate for the individual cable under test as specified by IEC 61000-4-6, whether or not the coupling/decoupling network includes a capacitor.

- *- *Subclause 6.2.2.1, Coupling and decoupling networks for power supply lines, last dash, does not apply.*
- *- *Subclause 6.4.1, Setting of the output level at the EUT port of the coupling device, is modified such that:*

- *The calibration accuracy of the IMMUNITY TEST LEVEL shall be to - 0 and +25 % in linear or - 0 and +2 dB in log quantities.*
- *Calibration for current injection clamps shall be performed in a 150 W system.*
- *Calibrations shall be performed using a frequency step size no greater than 1 % of the fundamental.*

- *- *Subclause 7.1.2, Test points, is replaced by the following:*

- *At least one representative cable of each FUNCTION on the EQUIPMENT and/or SYSTEM shall be tested.*
- *All PATIENT-coupled cables shall be tested, either individually or bundled, as specified in Subclause 7.1.1, Injection method.*
- *The power input cable shall be tested.*
- *The equipotential ground cable shall be tested.*

- *- *Subclause 7.3, Procedure for clamp injection when the common-mode impedance requirements cannot be met, shall be modified so that the reduced current injected under this condition is greater than or equal to the I_{max} specified, by the accuracy values of - 0 and + 25 % for linear or - 0 and + 2 dB for log quantities.*

- *- *The Alternative method of Subclause 7.5, EUT comprising several units, may only be applied when there is only one configuration of the SYSTEM.*

2. *Cables selected for testing for which a CDN is suitable shall have the*

CDN in place during the test. All CDNs that are not being used to inject the test signal shall be terminated with a 50 W load.

- *3. PATIENT-coupled cables shall be tested using a current clamp. In cases where a current clamp is not suitable, an EM clamp shall be used. CDNs are not suitable for, and shall not be applied to, PATIENT-coupled cables.*

PATIENT-coupled parts of EQUIPMENT and/or SYSTEMS shall be terminated during the test as specified below. In all cases, no intentional decoupling device shall be used between the injection point and the PATIENT coupling point.

- For PATIENT coupling points that do not have a conductive contact, the PATIENT coupling point shall be terminated with the artificial hand specified in CISPR 16-1. The metal foil of the artificial hand shall be applied to simulate the capacitive coupling effect of the PATIENT. The metal foil of the artificial hand shall be connected to the M terminal of the RC element of the artificial hand and the other terminal of the RC element of the artificial hand shall be connected to the ground reference plane.*
- For PATIENT coupling points that have conductive contact to the PATIENT, the M terminal of the RC element of the artificial hand (see CISPR 16-1) shall be connected directly to the conductive PATIENT connection, and the other terminal of the RC element shall be connected to the ground reference plane. If normal operation of the EQUIPMENT and/or SYSTEM cannot be verified with the M terminal of the artificial hand connected to the coupling point, an insulating material with a thickness of 5 mm or less may be applied between the metal foil of the artificial hand (see CISPR 16-1) and the PATIENT coupling point. In this case, the metal foil of the artificial hand shall be applied to simulate the capacitive coupling effect of the PATIENT and the M terminal of the RC element of the artificial hand shall be connected to the metal foil but not to the PATIENT coupling point. The other terminal of the RC element of the artificial hand shall be connected to the ground reference plane in all cases.*
- *- For EQUIPMENT and/or SYSTEMS that have multiple PATIENT coupling points or multiple PATIENT-coupled parts, each PATIENT coupling point and each PATIENT-coupled part shall have an artificial hand applied as specified above. The combined resistance and capacitance between the EQUIPMENT and/or SYSTEM and the ground reference plane, due to all applied artificial hands simulating the capacitive coupling effect of the PATIENT, shall be $510\text{ W} \pm 10\%$ in series with $220\text{ pF} \pm 20\%$.*

- *4. *HAND-HELD EQUIPMENT and/or parts of EQUIPMENT intended to be hand-held in NORMAL USE shall be tested with an artificial hand applied as specified in CISPR 16-1 to simulate the capacitive coupling effect of the OPERATOR, with the exception that PATIENT-coupled cables are tested as specified in 3, above. The artificial hand shall be connected to the ground reference plane.*
- *5. *Equipotential ground connections shall be tested using an M1 CDN. (See Figure D.2 in Annex D, Information on coupling and decoupling networks, of IEC 61000-4-6.)*
- *6. *For each cable injection, the test signal shall be 80 % amplitude modulated at the modulation frequency that is specified in Table 206 (see Subclause 36.202.3 b) 3), based upon the intended use of the EQUIPMENT and/or SYSTEM. (Unmodulated and modulated waveforms normalized to a generator output of 1,0 Vrms are shown in Figure 4 of IEC 61000-4-6). For EQUIPMENT and/or SYSTEMS for which testing at 2 Hz is required, it is not necessary to additionally test at 1 kHz. For EQUIPMENT and/or SYSTEM intended to monitor or measure a physiological parameter, the PHYSIOLOGICAL SIMULATION FREQUENCY restrictions specified in Table 206 shall apply. For EQUIPMENT and/or SYSTEMS intended to control a physiological parameter, the OPERATING FREQUENCY restrictions specified in Table 206 shall apply.*
- *7. *For the frequency step and dwell method (Clause 8, Test procedures, of IEC 61000-4-6):*

The minimum dwell time shall be based upon the time required for the EQUIPMENT and/or SYSTEM to be exercised (if applicable) and adequately respond to the test signal. The dwell time shall be at least 3 s for EQUIPMENT and/or SYSTEMS tested with a 2 Hz modulation frequency and 1 s for all other EQUIPMENT and/or SYSTEM and shall be no less than the response time of the slowest responding FUNCTION plus the settling time of the conducted RF IMMUNITY test system. For EQUIPMENT and/or SYSTEMS that average data over time for which faster-responding signals cannot be used to determine the effect of the test signal on the EQUIPMENT and/or SYSTEM, the dwell time shall be no less than 1,2 times the averaging period. If the averaging period is adjustable, the averaging period used to determine dwell time shall be that which is expected to be used most often in clinical application of the EQUIPMENT and/or SYSTEM. For EQUIPMENT and/or SYSTEMS for which faster-responding signals can be used to determine the effect of the test signal on the EQUIPMENT and/or SYSTEM, the dwell time may be reduced if the faster-responding signals are

monitored. In this case, the dwell time shall be no less than the response time of the signal or of the monitoring system, whichever is greater, plus the response time of the conducted RF IMMUNITY test system, but in no case less than 3 s for EQUIPMENT and/or SYSTEMS tested with a 2 Hz modulation frequency and 1 s for all other EQUIPMENT and/or SYSTEMS. For EQUIPMENT and/or SYSTEMS that have multiple individual parameters or sub-SYSTEMS, each of which would yield a different dwell time, the value used shall be the maximum of the individually-determined dwell times..

The frequency step size shall not exceed 1 % of the fundamental. (The next test frequency is less than or equal to the previous test frequency times 1,01.)

- *8. *For the continuous frequency sweep method (Clause 8, Test procedures, of IEC 61000-4-6):*

The rate of sweep shall not be greater than $(4,5/X) \times 10^{-3}$ decades/s where X is the dwell time in seconds determined from 7 above (the dwell time specified above for the frequency step and dwell method using a 1 % step size).

9. *Test conditions for EQUIPMENT and/or SYSTEMS with a receiving section for RF electromagnetic energy:*

The receiving section of the EQUIPMENT and/or SYSTEM shall be tuned to the preferred frequency of reception. If the receiving section of the EQUIPMENT and/or SYSTEM has no preferred frequency of reception, the receiving section of the EQUIPMENT and/or SYSTEM shall be tuned to the centre of the frequency range from which the frequency of reception can be selected.

10. *The test may be performed with the EQUIPMENT and/or SYSTEM powered at any one of its nominal power voltages and frequencies.*

36.202.7 Voltage dips, short interruptions and voltage variations on power supply input lines

***a) Requirements**

1. EQUIPMENT and/or SYSTEMS with a RATED input power of 1 kVA or less and all LIFE-SUPPORTING EQUIPMENT and/or SYSTEMS shall comply with the requirements of Subclause 36.202.1 j), *Compliance criteria*, at the IMMUNITY TEST LEVELS specified in Table 207. For EQUIPMENT and/or SYSTEMS that are not LIFE-SUPPORTING and for which the RATED input power is greater than 1 kVA and the RATED input current is less than or equal to 16

A per phase, deviation from the requirements of Subclause 36.202.1 j), *Compliance criteria*, is allowed at the IMMUNITY TEST LEVELS specified in Table 207, provided the EQUIPMENT and/or SYSTEM remains safe, experiences no component failures, and is restorable to the pre-test state with OPERATOR intervention. Determination of compliance is based upon performance of the EQUIPMENT and/or SYSTEM during and after application of the test sequence. EQUIPMENT and/or SYSTEMS that are not LIFE-SUPPORTING and for which the RATED input current exceeds 16 A per phase are exempt from the testing specified in Table 207.

2. EQUIPMENT and/or SYSTEMS are allowed a deviation from the requirements of Subclause 36.202.1 j), *Compliance criteria*, at the IMMUNITY TEST LEVEL specified in Table 208, provided the EQUIPMENT and/or SYSTEM remains safe, experiences no component failures, and is restorable to the pre-test state with OPERATOR intervention. Determination of compliance is based upon performance of the EQUIPMENT and/or SYSTEM during and after application of the test sequence.

LIFE-SUPPORTING EQUIPMENT and/or SYSTEMS for which this allowance for a deviation from the requirements of Subclause 36.202.1 j), *Compliance criteria*, is used shall provide an alarm, complying with applicable international standards, to indicate cessation of intended FUNCTION.

Voltage test level % U_T	Voltage dip % U_T	Duration Periods
< 5	> 95	0,5
40	60	5
70	30	25

Table 207
IMMUNITY TEST LEVELS for voltage dips

Voltage test level % U_T	Voltage dip % U_T	Duration Seconds
< 5	> 95	5

Table 208
IMMUNITY TEST LEVEL for voltage interruption

b) *Tests*

The test method and equipment specified by IEC 61000-4-11 shall apply with

the following modifications:

1. *Multiple phase EQUIPMENT and/or SYSTEMS shall be tested one phase at a time.*
2. *Test voltage changes shall be step changes and start at a zero crossing. For multiple phase EQUIPMENT and/or SYSTEMS, the zero crossing shall be referenced to the phase under test.*
3. *EQUIPMENT and/or SYSTEMS with a d.c. power input intended for use with a.c.-to-d.c. converters shall be tested using a converter that meets the specifications of the manufacturer of the EQUIPMENT and/or SYSTEM. The IMMUNITY TEST LEVELS shall be applied to the a.c. power input of the converter.*
4. *For EQUIPMENT and/or SYSTEMS that have, for power input, multiple voltage settings or autoranging voltage capability, the test shall be performed at the minimum and maximum RATED input voltages. The test shall be performed at the minimum RATED power frequency.*
5. *For EQUIPMENT and/or SYSTEMS with internal battery backup, it shall be verified that the EQUIPMENT and/or SYSTEM resumes operation from mains power after the tests specified in Table 207.*

***36.202.8 Magnetic fields**

36.202.8.1 Power frequency magnetic fields

***a) Requirements**

EQUIPMENT and/or SYSTEMS shall comply with the requirements of Subclause 36.202.1 j), *Compliance criteria*, at an IMMUNITY TEST LEVEL of 3 A/m.

Compliance is checked by the following tests and determined during and after the tests in accordance with Subclause 36.202.1 j), Compliance criteria:

b) Tests

The methods and equipment specified by IEC 61000-4-8 shall apply with the following modifications:

- *1. *Only the continuous field test shall be performed.*
 - *The test shall be performed at both 50 Hz and 60 Hz, with the exception that EQUIPMENT and/or SYSTEMS RATED for use only at one*

of these frequencies need only be tested at that frequency. In either case, during the test, the EQUIPMENT and/or SYSTEM shall be powered at the same frequency as the applied magnetic field.

- *If the EQUIPMENT and/or SYSTEM is internally powered or powered from an external d.c. supply, the test shall be performed at both 50 Hz and 60 Hz, with the exception that EQUIPMENT and/or SYSTEMS intended for use only in areas supplied at one of these frequencies need be tested only at that frequency.*

2. *The test may be performed with the EQUIPMENT and/or SYSTEM powered at any one of its nominal power voltages.*

***36.202.8.2 Pulsed magnetic fields**

No requirements apply.

***36.202.8.3 Damped oscillatory magnetic fields**

No requirements apply.

***36.202.9 Conducted disturbances in the range 0 Hz to 150 kHz**

No requirements apply.

***36.202.10 Oscillatory waves**

No requirements apply.

***36.202.11 Harmonics, interharmonics including mains signalling at a.c. power port**

No requirements apply.

***36.202.12 Ripple on d.c. power supply**

No requirements apply.

***36.202.13 Unbalance**

No requirements apply.

36.202.14 Variations of power frequency

The requirements of Subclause 10.2.2, *Power supply*, of IEC 60601-1 apply.

SECTIONS 6 to 10: Not used

Annex AAA
(informative)**General guidance and rationale***Subclause 1.201*

The scope of this standard includes ITE used in MEDICAL ELECTRICAL SYSTEMS through the definition of MEDICAL ELECTRICAL SYSTEMS. This standard should not be applied, without modification, to implantable MEDICAL ELECTRICAL EQUIPMENT.

Electrical/electronic infrastructure (e.g. existing local area networks, telecommunications networks, power networks) need not be tested for EMC in accordance with this standard as part of a MEDICAL ELECTRICAL SYSTEM. However, the effects of such electrical/electronic infrastructure should be assessed in accordance with IEC 60601-1-4 or ISO 14971-1, and electrical/electronic infrastructure intended to be used as part of a MEDICAL ELECTRICAL SYSTEM should be simulated during testing. Equipment provided by the manufacturer of the MEDICAL ELECTRICAL SYSTEM and intended to be connected to the SYSTEM by way of existing electrical/electronic infrastructure should meet the requirements of this standard. If local area networks and/or telecommunications networks are supplied as part of a MEDICAL ELECTRICAL SYSTEM by the manufacturer of the SYSTEM, they should be tested for EMC as specified in this standard, as part of the SYSTEM.

Subclause 2.203

The term "DEGRADATION" can apply to temporary or permanent failure.

Subclause 2.206

In this Collateral Standard for MEDICAL ELECTRICAL EQUIPMENT and/or SYSTEMS, it is inappropriate to imply that an ELECTROMAGNETIC DISTURBANCE might "adversely affect living (or inert) matter." As a consequence, in an otherwise unchanged text, this phrase of IEV definition 161-01-05 has not been retained.

Subclause 2.210

This definition is adapted from the "alignment range" specifications of ETSI 300 202.

Subclause 2.211

The following are examples of the FUNCTIONS of an EQUIPMENT and/or SYSTEM:

- The FUNCTIONS of a heart-rate monitor include measurement and display of heart rate, and may additionally include audible and visual alarms and display of the ECG waveform.

- The FUNCTIONS of an automatic external defibrillator include ECG analysis and defibrillation, and may additionally include ECG monitoring, pacing, and logging.

Subclause 2.217

The size chosen for this definition was based upon the limitations of typical test facilities. Physical limitations of door sizes and the uniform field area were considered.

Subclause 2.218

Both categories of EQUIPMENT and/or SYSTEMS, those used to keep PATIENTS alive and those used to resuscitate PATIENTS, are differentiated from other types of EQUIPMENT and/or SYSTEMS by the requirement to actively intervene to support life.

Subclause 2.220

The SYSTEM includes those ACCESSORIES that are needed for operating the SYSTEM as specified by the manufacturer.

Subclause 2.221

For example, the OPERATING FREQUENCY (fundamental) for a ventilator could be 0,1 Hz, (a rate of 6 breaths per minute). The signal could also contain harmonics to properly replicate the wave shape (I/E ratio) of a human respiratory cycle.

Subclause 2.222

This definition does not include inactive, mechanical PATIENT supports (e.g. bed rails, braces).

Subclause 2.223

For example, the simulation frequency (fundamental) for an ECG monitor could be 0,92 Hz (a heart rate of 55 beats per minute). The signal could also contain harmonics of several hundred Hz in order to have a wave shape that mimics that of a human.

Subclause 2.224

The PUBLIC MAINS NETWORK is referred to in Table 201 as the “public low-voltage power supply network that supplies buildings used for domestic purposes” to harmonize somewhat with CISPR 11 and because the tables are for the customer and/or user, who may not be familiar with this standard and its definitions. In CISPR 11, the PUBLIC MAINS NETWORK is called the “low-voltage power supply network which supplies buildings used for domestic purposes” and “domestic electricity power supplies,” and in IEC 61000-3-2 and IEC 61000-3-3 it is called the “public supply

system,” the “public low-voltage system,” and the “public low-voltage distribution system.”

Subclause 3.201.1

Compliance with this requirement is demonstrated by compliance with the requirements of this standard. Compliance with the requirement that EQUIPMENT and/or SYSTEMS shall not emit ELECTROMAGNETIC DISTURBANCES that could affect radio services, other equipment, or the CRITICAL FUNCTIONS of other EQUIPMENT and/or SYSTEMS is demonstrated by compliance with the requirements of Clause 6, *Identification, marking and documents* and Subclause 36.201, *EMISSIONS*, of this standard. Compliance with the requirement that CRITICAL FUNCTIONS of EQUIPMENT and/or SYSTEMS have adequate IMMUNITY to ELECTROMAGNETIC DISTURBANCES is demonstrated by compliance with the requirements of Clause 6 and of Subclause 36.202, *IMMUNITY*, of this standard.

Subclause 3.201.2

If this risk analysis is performed and the CRITICAL FUNCTIONS of the EQUIPMENT and/or SYSTEM have been identified, the CRITICAL FUNCTIONS should meet the requirements of Subclause 36.202, *IMMUNITY*. If this risk analysis is not performed, all FUNCTIONS of the EQUIPMENT and/or SYSTEM must meet the requirements of Subclause 36.202, *IMMUNITY*.

Consideration should be given to ISO 14971-1 and IEC 60601-1-4 for this risk analysis.

Subclause 3.201.4

Consideration should be given to ISO 14971-1 and IEC 60601-1-4 for this risk analysis.

Subclause 6.1.201.1

EQUIPMENT that apply RF electromagnetic energy for diagnosis and/or treatment are usually CISPR 11 Group 2. This requirement does not apply to monitoring EQUIPMENT and/or SYSTEMS (e.g. impedance plethysmography (respiration and/or apnea) monitors).

Subclause 6.8.201.1 a) 1 and 2

The use of ACCESSORIES, cables and transducers other than those for which the EQUIPMENT and/or SYSTEM was designed can significantly degrade EMISSIONS and IMMUNITY performance. Therefore, a warning on the use of ACCESSORIES, transducers and cables other than those specified in the ACCOMPANYING DOCUMENTS is necessary to help ensure that the user will be able to operate the EQUIPMENT and/or SYSTEM as

intended.

Subclause 6.8.201.1 a) 3

Unless EQUIPMENT and/or SYSTEMS have an extremely high level of IMMUNITY (e.g. radiated IMMUNITY of 200 V/m, ESD IMMUNITY of 35 kV) and a low level of EMISSIONS (e.g. CISPR 11 Group I, Class B), it will always be necessary for the customer and/or the user to manage the ELECTROMAGNETIC ENVIRONMENT. The tables and other guidance that are required to be included in the ACCOMPANYING DOCUMENTS provide information to the customer and/or user that is essential in determining the suitability of the EQUIPMENT and/or SYSTEM for the ELECTROMAGNETIC ENVIRONMENT of use, and in managing the ELECTROMAGNETIC ENVIRONMENT of use to permit the EQUIPMENT and/or SYSTEM to perform as intended without disturbing other EQUIPMENT and/or SYSTEMS and/or non-medical equipment.

Subclause 6.8.201.1 a) 4

The tests and general limits and test levels of this standard do not address ELECTROMAGNETIC COMPATIBILITY of electrical equipment at very close distances. Unless all electrical equipment is compatible with respect to both electric fields and magnetic fields at very close distances over the entire range of expected frequencies, separation is prudent. If it is essential to use the EQUIPMENT and/or SYSTEM very close to other electrical equipment, it is prudent to determine, by observation, if the performance of either product is affected by unintended electromagnetic coupling.

Subclause 6.8.201.1 a) 5

A justification for lower COMPLIANCE LEVELS is required to be included in the ACCOMPANYING DOCUMENTS to convey to the customer and/or user that there are physical, technological and/or physiological limitations to the ability of the EQUIPMENT and/or SYSTEM to perform as intended in the presence of ELECTROMAGNETIC DISTURBANCES. This will also help to emphasize the importance of the associated additional guidance, in the tables, for managing the ELECTROMAGNETIC ENVIRONMENT.

For the IEC 61000-4-11 IMMUNITY test, "lower COMPLIANCE LEVELS" (Subclause 36.202.1 a), IEC 60601-1-2 TEST LEVELS) means shorter duration of the voltage dip or interruption, and/or less of a dip in voltage. Similarly, "higher COMPLIANCE LEVELS" means longer duration of the voltage dip or interruption, and/or more of a dip in voltage.

Subclause 6.8.201.1 a) 6

Unless EQUIPMENT and/or SYSTEMS have an extremely high level of IMMUNITY (e.g. radiated IMMUNITY of 200 V/m, ESD IMMUNITY of 35 kV), it will always be necessary for the customer and/or the user to manage the ELECTROMAGNETIC ENVIRONMENT. The tables that are required to be included in the ACCOMPANYING DOCUMENTS provide information to the customer and/or user that is essential in determining the suitability of

the EQUIPMENT and/or SYSTEM for the ELECTROMAGNETIC ENVIRONMENT of use, and in managing the ELECTROMAGNETIC ENVIRONMENT of use to permit the EQUIPMENT and/or SYSTEM to perform as intended.

Subclause 6.8.201.1 a) 6 second dash

The restriction on lower and higher COMPLIANCE LEVELS that can be claimed is intended to ensure that if lower COMPLIANCE LEVELS are justified or higher levels claimed, they differ from the IEC 60601-1-2 TEST LEVEL by an amount that is significant from an EMC standpoint.

All IMMUNITY tests are applicable unless the EQUIPMENT and/or SYSTEM is outside the scope of an EMC basic standard, Subclause 36.202, *IMMUNITY*, specifies that the test is not applicable, or it is not possible to perform the test for the particular EQUIPMENT and/or SYSTEM. For example, the IEC 61000-4-11 test would not be applicable for battery-operated EQUIPMENT that has no provision for connection to a.c. power.

Subclause 6.8.201.1 a) 6 third dash

If the COMPLIANCE LEVEL equals the IEC 60601-1-2 TEST LEVEL for each IMMUNITY test, no changes to the guidance in column 4 of Table 202 should be made. For IMMUNITY tests for which the COMPLIANCE LEVEL is lower than the IEC 60601-1-2 TEST LEVEL (and justified), example text for column 4 of Table 202 appears below. If the COMPLIANCE LEVEL is higher than the IEC 60601-1-2 TEST LEVEL for an IMMUNITY test, the manufacturer of the EQUIPMENT and/or SYSTEM may choose either to use the existing text in column 4 of Table 202 without modification, or to describe the characteristics of the ELECTROMAGNETIC ENVIRONMENT in which the EQUIPMENT and/or SYSTEM is suitable due to its higher IMMUNITY. One example of text for column 4 of Table 202 for EQUIPMENT and/or SYSTEMS for which the COMPLIANCE LEVEL is higher than the IEC 60601-1-2 TEST LEVEL for the IEC 61000-4-11 test appears below (see Re: 36.202.7, *Voltage dips, short interruptions and voltage variations on power supply input lines*).

- Re: Subclause 36.202.2, *Electrostatic discharge (ESD)*

For example, if test level 2 (± 4 kV contact discharge and ± 4 kV air discharge) is claimed (and justified), it may be necessary to recommend the use of anti-static materials and/or higher relative humidity. If test level 4 (± 8 kV contact discharge and ± 15 kV air discharge) is claimed, the EQUIPMENT and/or SYSTEM could be specified for use in a dry environment.

- Re: 36.202.4, *Electrical fast transients and bursts*

For example, if a lower COMPLIANCE LEVEL is claimed (and justified), it may be necessary to recommend the use of filters on power input lines and/or minimum separation between signal lines and power lines.

- Re: 36.202.5, *Surges*

For example, if a lower COMPLIANCE LEVEL is claimed (and justified), it may be necessary to recommend the use of surge suppression devices.

- Re: 36.202.7, *Voltage dips, short interruptions and voltage variations on power supply input lines*

For this test, "lower COMPLIANCE LEVELS" (see Subclause 36.202.1 a), *IEC 60601-1-2 TEST LEVELS*) means shorter duration of the voltage dip or interruption, and/or less of a dip in voltage. Similarly, "higher COMPLIANCE LEVELS" means longer duration of the voltage dip or interruption, and/or more of a dip in voltage.

If a lower COMPLIANCE LEVEL is claimed (and justified), it may be necessary to make additional recommendations regarding the use of uninterruptible power supplies, batteries, or other power conditioning equipment.

For EQUIPMENT and/or SYSTEMS with internal batteries that can meet a higher IMMUNITY TEST LEVEL for the IEC 61000-4-11 voltage interruption test, the guidance in column 4 may be revised accordingly. If, for example, a ventilator meets the requirements of Subclause 36.202.1 j), *Compliance criteria*, at an IMMUNITY TEST LEVEL of $< 5 \% U_T$ for 24 hours, the text in column 4 could be replaced with the following (or equivalent):

Mains power quality should be that of a typical commercial and/or hospital environment. If an interruption of mains power occurs, the [EQUIPMENT and/or SYSTEM] is capable of continued operation for a minimum of 24 hours, provided the batteries are charged prior to the interruption of mains power.

- Re: 36.202.8.1, *Power frequency magnetic fields*

For example, if a lower COMPLIANCE LEVEL is claimed (and justified), it may be necessary to recommend positioning the EQUIPMENT and/or SYSTEM further from sources of power frequency magnetic fields or installation of magnetic shielding.

Subclause 6.8.201.1 b)

See Annex BBB for examples of completion of Tables 203a, 203b, 204a, and 204b.

See Annex AAA, Subclause 6.8.201.1 a) 6

The restriction on lower and higher COMPLIANCE LEVELS that can be claimed is intended to ensure that if lower IMMUNITY TEST LEVELS are justified or higher levels claimed, they differ from the IEC 60601-1-2 TEST LEVEL by an amount that is significant from an EMC standpoint.

The increased radiated RF IMMUNITY TEST LEVEL for LIFE-SUPPORTING EQUIPMENT

and/or SYSTEMS is intended as an additional safety margin to decrease the likelihood that a portable communications device, such as a radio (cellular/cordless) telephone, could cause DEGRADATION of an EQUIPMENT and/or SYSTEM that results in harm to a PATIENT if the communications device is brought into PATIENT areas. This requirement is not intended to permit the use of such portable communications devices closer to EQUIPMENT and/or SYSTEMS. Therefore, for LIFE-SUPPORTING EQUIPMENT and/or SYSTEMS, the calculation of the recommended maximum field strength and minimum separation distance takes this safety margin into account. An additional factor of 10/3 is used in the recommended separation distance equations for the ISM frequency bands between 150 kHz and 80 MHz and in the frequency range 80 MHz to 2,5 GHz

Four equations are used to calculate the recommended separation distances in Tables 203a, and 204a, and three equations are used to calculate the recommended separation distances in Tables 203b, and 204b. V_1 and V_2 are used in the frequency range 150 kHz to 80 MHz because the IEC 61000-4-6 conducted RF IMMUNITY test is used as a substitute for radiated RF IMMUNITY testing in that frequency range. The constants used in the equations are based on the following assumptions regarding mobile/portable RF transmitters:

- Propagation is isotropic;
- The antenna efficiency approximates that of an ideal dipole for transmitters with frequencies above 800 MHz;
- The antenna efficiency is approximately half that of an ideal dipole for transmitters with frequencies below 800 MHz;
- Antennas with gain are not usually used in mobile/portable communications equipment.

For EQUIPMENT and/or SYSTEMS that are specified for use only in a shielded location and that comply with reduced RF IMMUNITY TEST LEVELS based upon the shielding effectiveness / filter attenuation of the specified shielded location (See Subclause 36.202.3 a) 3, *EQUIPMENT and/or SYSTEMS specified for use only in a shielded location*, and Subclause 36.202.6 a) 3, *EQUIPMENT and/or SYSTEMS specified for use only in a shielded location*), it is not meaningful to discuss separation distances. For this reason, Table 205a is used instead of Tables 203a and 204a, and Table 205b is used instead of Tables 203b and 204b. (See also Subclause 6.8.201.1 c) 4.)

Subclause 6.8.201.1 c) 2

EQUIPMENT and/or SYSTEMS may need to be specified for use only in a shielded location as a result of either the EMISSIONS or IMMUNITY characteristics of the EQUIPMENT and/or SYSTEM. The specifications for the shielded location that result from the EMISSIONS characteristics and the specifications for the shielded location that result from the IMMUNITY characteristics of the EQUIPMENT and/or SYSTEM must be identical because they apply to the same shielded location.

The minimum value for both the RF shielding effectiveness and the RF filter attenuation must be specified over the same frequency range so that radiated RF will not bypass the filters and conducted RF will not bypass the shielding. The frequency bands for the RF EMISSIONS tests are 150 kHz to 30 MHz and 30 MHz to 2,5 GHz. The frequency ranges for the RF IMMUNITY tests are 150 kHz to 80 MHz and 80 MHz to 2,5 GHz. For simplicity and to ensure effectiveness of both shielding and filters, the specified RF shielding effectiveness / filter attenuation must apply over the entire frequency range 150 kHz to 2,5 GHz.

If use only in a shielded location is specified to comply with the IEC 61000-4-6 test, the specified RF filter attenuation and shielding effectiveness must have the same value because the test is performed on cables, yet it is intended to simulate the effect of radiated RF sources.

Thus, there can be only one specified value for RF shielding effectiveness / filter attenuation for both EMISSIONS and IMMUNITY, it must be the highest value required to meet all of the radiated and/or conducted RF EMISSIONS and/or IMMUNITY tests, and it must apply over the entire frequency range 150 kHz to 2,5 GHz. This value becomes the specification for the minimum RF shielding effectiveness and filter attenuation for the shielded location in which the EQUIPMENT and/or SYSTEM should be used.

If the shielded location is required as a result of the or IMMUNITY characteristics of the EQUIPMENT and/or SYSTEM, the manufacturer may choose not to use the EMISSIONS allowance in Subclause 36.201.1 a) 4, *EQUIPMENT and/or SYSTEMS specified for use only in a shielded location*. If this allowance is not used, it is not necessary to add the text specified in Subclause 6.8.201.1 c) 2 to Table 201.

Subclause 6.8.201.1 c) 3

For example, a manufacturer might specify that equipment such as high-frequency surgery EQUIPMENT, radio (cellular/cordless) telephones, and walkie talkies should be prohibited from inside the shielded location when the EQUIPMENT and/or SYSTEM is in use.

Whether or not a shielded location is specified as a result of the IMMUNITY characteristics of the EQUIPMENT and/or SYSTEM (e.g. it could be specified as a result of the EMISSIONS characteristics), RF reflections in a shielded location result in field strengths at various locations within the room that do not necessarily decrease with distance as predicted by the equations in Figures 203a through 204b. Therefore, caution would dictate that RF transmitters should not be used inside the specified shielded location.

A recommendation should be made to the customer to post signs at all entrances to shielded locations regarding equipment allowed and/or prohibited because of the importance of this requirement and the fact that the information in the ACCOMPANYING DOCUMENTS is not likely be readily available to health-care providers, PATIENTS, and/or

visitors.

Subclause 6.8.201.1 c) 4

See Annex BBB for an example of completion of Table 205a.

See Annex AAA, Subclause 6.8.201.1 a) 6

The restriction on lower and higher COMPLIANCE LEVELS that can be claimed is intended to ensure that if lower IMMUNITY TEST LEVELS are justified or higher COMPLIANCE LEVELS are claimed, they differ from the IEC 60601-1-2 TEST LEVEL by an amount that is significant from an EMC standpoint.

For EQUIPMENT and/or SYSTEMS that are specified for use only in a shielded location and that comply with reduced RF IMMUNITY TEST LEVELS based upon the shielding effectiveness / filter attenuation of the specified shielded location (See Subclause 36.202.3 a) 3, *EQUIPMENT and/or SYSTEMS specified for use only in a shielded location*, and Subclause 36.202.6 a) 3, *EQUIPMENT and/or SYSTEMS specified for use only in a shielded location*), it is not meaningful to discuss separation distances. For this reason, Table 205a is used instead of Tables 203a and 204a, and Table 205b is used instead of Tables 203b and 204b.

Subclause 6.8.201.1 c) 4 third dash

See Annex AAA, Subclause 6.8.201.1 c) 2.

Subclause 6.8.201.1 g)

The use of an ACCESSORY, cable and/or transducer other than those for which the EQUIPMENT and/or SYSTEM was designed and/or tested can significantly degrade EMISSIONS and IMMUNITY performance. Therefore, a warning on the use of the ACCESSORY, transducer and cable with EQUIPMENT and/or SYSTEMS other than those specified in the ACCOMPANYING DOCUMENTS is necessary to help assure that the user will be able to operate EQUIPMENT and/or SYSTEMS as intended. If a third-party supplier offers ACCESSORIES, cables or transducers for use with an EQUIPMENT and/or SYSTEM and they are not listed or specified in the ACCOMPANYING DOCUMENTS for the EQUIPMENT and/or SYSTEM, it is the responsibility of that third-party supplier or the customer to determine compliance with the requirements of this standard for the EQUIPMENT and/or SYSTEM when used with the ACCESSORY, cable and/or transducer.

Subclause 6.8.201.1 h) 3

Types of modulation are listed in the ITU Radio Regulations, Volume 2, *Appendices*, Appendix S1, *Classification of emissions and necessary bandwidths*, Section II - *Classification*, Sub-Section IIA, *Basic characteristics*.

Subclause 6.8.201.2 b) 2

Staff must be made aware that accessible pins of connectors identified with the ESD warning symbol should not be touched with the fingers or with a hand-held TOOL unless proper precautionary procedures have been followed.

Precautionary procedures include:

- Methods to prevent build-up of electrostatic charge (e.g. air conditioning, humidification, conductive floor coverings, non-synthetic clothing);
- Discharging one's body to the frame of the EQUIPMENT and/or SYSTEM and/or to earth or a large metal object;
- Bonding oneself by means of a wrist strap to the EQUIPMENT and/or SYSTEM or to earth.

Subclause 6.8.201.2 b) 3

Staff that could touch connectors identified with the ESD warning symbol should receive this explanation and training. This includes clinical/biomedical engineering and health-care staff.

Subclause 6.8.201.2 b) 4

ESD training should include an introduction to the physics of electrostatic charge, the voltage levels that can occur in normal practice and the damage that can be done to electronic components if they are touched by an OPERATOR who is electrostatically charged. Further, an explanation should be given of methods to prevent build-up of electrostatic charge, and how and why to discharge one's body to earth and/or to the frame of the EQUIPMENT and/or SYSTEM, or bond oneself by means of a wrist strap to the EQUIPMENT and/or SYSTEM, or to earth prior to making a connection.

Subclause 36.201.1 a)

For MEDICAL ELECTRICAL EQUIPMENT and/or SYSTEMS, the CISPR 11 product family standard is used as a basic EMC standard. See also definition 2.220, *MEDICAL ELECTRICAL SYSTEM*.

Subclause 36.201.1 a) 1

It is likely that when CISPR 14 EQUIPMENT is combined with other (e.g. CISPR 11) EQUIPMENT to form a SYSTEM, its interconnecting cables would emanate RF electromagnetic energy generated by other sources. Therefore, additional EMISSIONS testing in accordance with CISPR 11 would be required.

Subclause 36.201.1 a) 3

The definition of CISPR 11 Group 1, Class A and Class B (ISM) equipment is generally similar to that of CISPR 22 Class A and Class B (ITE). The conducted and radiated EMISSION limits and the measuring methods are similar in both standards. This means that equipment complying with the CISPR 22 Class A requirements automatically complies with the CISPR 11, Group 1, Class A requirements and equipment complying with the CISPR 22 Class B requirements also complies with the CISPR 11, Group 1, Class B requirements. As both standards address subsystem testing and the requirements are essentially identical, there is no need to require testing of the SYSTEM to ensure that the incorporation of compliant ITE does not degrade the performance of the SYSTEM.

While ITE used as part of a MEDICAL ELECTRICAL SYSTEM may be classified in accordance with CISPR 22, EQUIPMENT and/or SYSTEMS may not be classified in accordance with CISPR 22.

Subclause 36.201.1 a) 4

See Annex AAA, Subclause 6.8.201.1 c) 2.

If it is necessary to specify use only in a shielded location as a result of the IMMUNITY characteristics of the EQUIPMENT and/or SYSTEM, a manufacturer could choose not to take advantage of this EMISSIONS testing allowance.

Subclause 36.201.1 b) 1

CISPR 11 requires the attachment of all cables and a NORMAL USE condition for the EQUIPMENT and/or SYSTEM. PATIENT cables are considered part of this requirement. It is necessary to provide sufficient simulation so that the EQUIPMENT and/or SYSTEM can operate in a NORMAL USE condition. This PATIENT simulation should be designed so as not to reduce the EMISSIONS of the EQUIPMENT and/or SYSTEM or to add unintentional EMISSIONS from the simulator. The effect of the PATIENT on EMISSIONS is not considered critical; however, if a general PATIENT RF model is developed, this will be reconsidered.

Subclause 36.201.1 b) 2

Because of the variety of SYSTEM configurations, testing of sub-SYSTEMS is allowed. Any simulator used in lieu of an actual EQUIPMENT should properly represent the electrical and in some cases the mechanical characteristics of the interface, especially with respect to RF signals and impedances, as well as cable configuration and types.

Subclause 36.201.2.1

Magnetic field EMISSIONS requirements below 9 kHz are under consideration.¹³

¹³ Under consideration by IEC SC 77A and IEC SC 62A.

Subclause 36.201.3.1 a)

IEC 61000-3-2 is applicable only to equipment with a RATED mains voltage including 230 V and that is intended for connection to the PUBLIC MAINS NETWORK. If an EQUIPMENT and/or SYSTEM is not intended to be connected to the PUBLIC MAINS NETWORK, this requirement is not applicable. Examples of locations connected to the PUBLIC MAINS NETWORK are residences, doctors' offices and small clinics. A location is served from the PUBLIC MAINS NETWORK if more than one customer is served from the same output of a medium or high voltage electric distribution transformer.

Subclause 36.201.3.2 a)

See Annex AAA, Subclause 36.201.3.1 a).

Subclause 36.202.1

For IMMUNITY testing, the test methods and guidance for selection of test levels that appear in the associated basic EMC IMMUNITY standards have been followed, except in cases where there are special considerations particular to EQUIPMENT and/or SYSTEMS. Deviations from the basic EMC IMMUNITY standards have been kept to a minimum.

Subclause 36.202.1 a)

Because the practice of medicine involves many specialities, there will by necessity be EQUIPMENT and/or SYSTEMS that are designed to perform a variety of FUNCTIONS. Some FUNCTIONS involve, for example, measurement of signals from a PATIENT that are of very low levels when compared to ELECTROMAGNETIC NOISE levels that can be coupled into EQUIPMENT and/or SYSTEMS during the ELECTROMAGNETIC IMMUNITY testing specified in this standard. Because of the proven benefit of many such EQUIPMENT and/or SYSTEMS, this standard allows the IMMUNITY TEST LEVELS to be lowered, provided there is sufficient justification based on physical, technological and/or physiological limitations. There is a recommendation in Annex DDD, Subclause DDD2 a) that this allowance be removed when this standard is applied in a product specific standard because, for a specific product, it should be possible to specify a minimum level of IMMUNITY. Thus, if justified, IMMUNITY TEST LEVELS lower than the IEC 60601-1-2 TEST LEVELS may be specified in part two (IEC 60601-2-x) standards; however, an allowance for even lower levels than that should not be made, i.e. should be removed.

Subclause 36.202.1 c)

Consideration should be given to ISO 14971-1 and IEC 60601-1-4 for this risk analysis.

Subclause 36.202.1 d)

Consideration should be given to ISO 14971-1 and IEC 60601-1-4 for this risk analysis.

Non-medical equipment often have IMMUNITY requirements that are different from those specified by this standard. The exclusion from IMMUNITY testing according to this standard of non-medical equipment that is not expected to affect the CRITICAL FUNCTIONS of the SYSTEM if the non-medical equipment exhibits DEGRADATION permits the use in a SYSTEM of non-medical equipment that may not comply with the requirements of this standard. An example of such equipment is a printer used in an EQUIPMENT and/or SYSTEM in which the information to be printed remains in the memory of the EQUIPMENT until it is intentionally deleted, and the information can be re-transmitted to the printer and re-printed in the case of interference with printer operation. The *Instructions for use* of the MEDICAL ELECTRICAL SYSTEM should caution the user to verify proper operation of the printer before deleting stored data. In contrast, a non-medical equipment (such as an ITE) used as a PATIENT monitoring central station would likely be subject to the IMMUNITY requirements of this standard, depending upon the results of a risk analysis, because loss or corruption of PATIENT information at the monitoring central station can reasonably be expected to affect the safety of the PATIENT.

Once equipment that could affect the CRITICAL FUNCTIONS of the EQUIPMENT and/or SYSTEM has been identified, that equipment should meet the requirements of Subclause 36.202, *IMMUNITY*.

Subclause 36.202.1 e)

The requirement that PATIENT-COUPLED EQUIPMENT and/or SYSTEMS shall be tested so that the PATIENT coupling point is within the test environment and does not have an intentional conductive and/or capacitive connection to ground during testing, except as otherwise specified in a subclause of this standard, is to ensure that the PATIENT cable is tested in a worst-case condition. In cases where an intentional capacitive connection has been specified (i.e. the artificial hand), this is considered the worst case. Unintentional capacitance between the PATIENT coupling point and ground should be limited to 250 pF. IEC 60601-1 treats the conditions in which the PATIENT is floating and in which the PATIENT is grounded as NORMAL CONDITIONS. However, from a RF perspective, it is unlikely that a PATIENT would ever be as effectively grounded in a medical environment as would happen in an EMC test environment if a direct ground reference were used. As a result, the artificial hand specified in CISPR 16-1 is used to represent the grounded condition.

Subclause 36.202.1 f)

The requirement to test variable gain EQUIPMENT and/or SYSTEMS at the highest gain setting that allows proper operation is necessary because the signal-to-noise ratio in this mode would be significantly worse than if tested with a low gain setting, which

might lead to an erroneous determination of satisfactory performance.

Subclause 36.202.1 g)

Details of simulators used for PATIENT-COUPLED EQUIPMENT, using the guidelines in this standard, should be defined more specifically in Particular (IEC 60601-2-X and ISO standards based on IEC 60601-1) Standards. Care should be taken that the simulators used perturb the test minimally and do not exhibit DEGRADATION as a result of the IMMUNITY TEST LEVEL. The PATIENT physiological simulator is not intended to represent the RF characteristics of the human body. As a result, there may be differences between the RF energy coupled into the EQUIPMENT and/or SYSTEM when using only a PATIENT physiological simulator when compared to use on an actual PATIENT.

See Annex AAA, Subclause 36.202.1 e).

The requirements for EQUIPMENT and/or SYSTEM sensitivity adjustments and/or setting of the simulated PATIENT physiological signal are intended to ensure that the EQUIPMENT and/or SYSTEM will operate as intended over the range of input PATIENT physiological signals for which the EQUIPMENT and/or SYSTEM was designed.

For EQUIPMENT and/or SYSTEMS without manual sensitivity adjustments (non-adjustable gain or automatic gain control) it is assumed that during use of the EQUIPMENT and/or SYSTEM, an OPERATOR will not always be present to monitor the PATIENT signal and ensure that the EQUIPMENT and/or SYSTEM is operating according to the ACCOMPANYING DOCUMENTS. However, it is assumed that an OPERATOR would be able to see an indication of inadequate signal strength. For this case, it is appropriate to test the EQUIPMENT and/or SYSTEM with the input simulated PATIENT physiological signal set to either the lowest amplitude and/or value consistent with normal operation specified by the manufacturer or to the minimum amplitude and/or value at which the EQUIPMENT and/or SYSTEM operates as intended. Requirements for the minimum amplitude and/or value at which the EQUIPMENT and/or SYSTEM should operate as intended can be defined more specifically in Particular (IEC 60601-2-X and ISO standards based on IEC 60601-1) Standards.

For EQUIPMENT and/or SYSTEMS that have a manual sensitivity adjustment, it is assumed that during use of the EQUIPMENT and/or SYSTEM, the OPERATOR will be present to monitor the PATIENT signal and ensure that the EQUIPMENT and/or SYSTEM is operating according to the ACCOMPANYING DOCUMENTS. For this case, it is appropriate to test the EQUIPMENT and/or SYSTEM while it is operating at its most sensitive setting with a simulated PATIENT physiological signal set according to the manufacturer's sensitivity adjustment guidelines.

Subclause 36.202.1 h)

While the effect of the IMMUNITY TEST LEVEL on some FUNCTIONS of an EQUIPMENT and/or SYSTEM (e.g. tidal volume delivered by a ventilator, O₂ value displayed by an inspired O₂ monitor) may be readily apparent during IMMUNITY testing, others (e.g.

bubble detection in a dialysis SYSTEM) may not. It is essential that CRITICAL FUNCTIONS of the EQUIPMENT and/or SYSTEM be assessed, in a practical manner, during IMMUNITY testing.

In the case of critical alarms for example, it may not be practical, particularly during radiated RF IMMUNITY testing, to repeatedly establish normal values of PATIENT and/or EQUIPMENT and/or SYSTEM parameters, simulate an alarm condition, re-establish normal values, and reset the EQUIPMENT and/or SYSTEM. For parameters that are normally displayed, it would be sufficient to observe the displayed values to determine if they are influenced by a DISTURBANCE in a manner that could cause the EQUIPMENT and/or SYSTEM to fail to alarm under alarm conditions. EQUIPMENT and/or SYSTEMS should be designed to permit observation and verification, during the test, of parameters used to perform CRITICAL FUNCTIONS (e.g. derive critical alarms). However, for parameters that are not normally displayed, are used to perform CRITICAL FUNCTIONS (e.g. triggering of critical alarms), and on which the effect of the DISTURBANCE might not be readily apparent during IMMUNITY testing, special test software and/or hardware must be used so that the effect of the DISTURBANCE on these parameters can be observed during the test.

NOTE Assessment of displayed values depends in part on the ability of the observer to correctly distinguish between a normally-functioning display and a "frozen" display.)

In many cases, analogue circuitry is more sensitive to DISTURBANCES than digital circuitry. Further, digital systems are used to process and display many analogue signals in modern equipment. Therefore if analogue signals are sensed, amplified properly and correctly displayed, it can in many cases be assumed that the logical decisions of the EQUIPMENT and/or SYSTEM would be correct. However, as digital circuitry can sometimes be affected by DISTURBANCES as well, care should be exercised in assessing proper display of values and proper logical decisions.

An example of a CRITICAL FUNCTION the performance of which can normally be determined during IMMUNITY testing is the tidal volume delivered by a ventilator. This parameter would normally be measured with the use of a ventilator tester in order to assess the performance of the ventilator during the test.

Another example of a CRITICAL FUNCTION the performance of which can normally be determined during IMMUNITY testing is an EQUIPMENT and/or SYSTEM that displays inspired O₂. Assuming that the displayed O₂ value is used to trigger alarms and that it can be determined that the display continues to be updated normally, it can be assumed that if the accuracy of the O₂ value displayed during IMMUNITY testing remains within an acceptable range, then a low O₂ alarm would be activated if the actual O₂ were to fall below a typical alarm threshold. It would not be necessary to adjust the alarm threshold so that an alarm actually occurred, as this would slow the testing considerably.

An example of a CRITICAL FUNCTION the performance of which cannot normally be determined during IMMUNITY testing is a bubble detection alarm in dialysis EQUIPMENT.

Because the value sensed from the bubble detector is not normally displayed, it would be necessary to add a display of, for example, viscosity or acoustical impedance in order to determine if this parameter would be affected by the IMMUNITY TEST LEVEL in a way that would prevent the bubble alarm from activating.

Subclause 36.202.1 i)

Any simulator used in lieu of an actual EQUIPMENT should properly represent the electrical and in some cases the mechanical characteristics of the interface, especially with respect to RF signals and impedances, as well as cable configuration and types.

Subclause 36.202.1 j)

A reasonable starting point to quantify the amount of DEGRADATION (e.g. error) that might be acceptable during IMMUNITY testing, in accordance with the requirements of Subclause 36.202.1 j), *Compliance criteria*, is the manufacturer's accuracy specification in the ACCOMPANYING DOCUMENTS, with the modification that all other sources of error normally accounted for in the accuracy specification are disregarded and the total accuracy deviation is allocated to the response of the EQUIPMENT and/or SYSTEM to the IMMUNITY TEST LEVEL. If additional accuracy deviations are considered acceptable, the deviation should be determined from consultations with clinicians whose experience and area of expertise include the use of the particular EQUIPMENT and/or SYSTEM, and this information should be included in the ACCOMPANYING DOCUMENTS.

If lower COMPLIANCE LEVELS can be justified as specified in Subclause 36.202.1 a), *IEC 60601-1-2 TEST LEVELS*, the IMMUNITY LEVEL may be determined by reducing the IMMUNITY TEST LEVEL until the compliance criteria in Subclause 36.202.1 j) are met. For example, if lower COMPLIANCE LEVELS are justified and the IEC 60601-1-2 TEST LEVEL results in false PATIENT alarms, the IMMUNITY TEST LEVEL may be reduced to the point just below which the false PATIENT alarms do not occur. This reduced test level will be the IMMUNITY LEVEL. The COMPLIANCE LEVEL can then be determined from the IMMUNITY LEVEL as specified in Subclauses 6.8.201.1 a) 6 second dash, 6.8.201.1 b) 2, or 6.8.201.1 c) 4 second dash.

Examples of conformance to the compliance criteria:

- An imaging SYSTEM displays an image that may be altered, but in a way that is recognizable as other than physiologic and that would not affect the diagnosis or treatment.
- A heart rate monitor displays a heart rate that may be in error by a clinically insignificant amount.
- A PATIENT monitor exhibits a small amount of noise or a transient on a waveform that is recognizable as other than physiologic and that does not affect diagnosis or

treatment.

Examples of EQUIPMENT and/or SYSTEMS with multiple FUNCTIONS:

- multi-parameter monitors
- anaesthesia SYSTEMS with monitors
- ventilators with monitors
- multiple instances of the same FUNCTION (e.g. multiple invasive blood pressure sensors)

Failure of therapy EQUIPMENT to terminate a treatment at the intended time is considered cessation of an intended operation.

If the effect of the test signal on an EQUIPMENT and/or SYSTEM is so brief as to be transparent to the PATIENT and/or OPERATOR and does not affect diagnosis, monitoring or treatment of the PATIENT, this can be considered not to be cessation of an intended operation. For example, if in response to the IMMUNITY TEST LEVEL a ventilator stops pumping for 50 ms and then resumes operation such that accuracy is within acceptable limits, this would not be considered cessation of an intended operation.

Subclause 36.202.1 j), *Compliance criteria*, requires that EQUIPMENT and/or SYSTEMS remain safe under the test conditions of Subclause 36.202, *IMMUNITY*. A risk analysis should be performed to determine this. Consideration should be given to ISO 14971-1 and IEC 60601-1-4 for the risk analysis.

Subclause 36.202.2 a)

According to IEC 61000-4-2, the IMMUNITY TEST LEVEL of ± 4 kV for both air and contact discharge are adequate for the materials of wood, concrete and ceramic at all humidity levels (e.g. when floors consist of these materials). However, the IMMUNITY TEST LEVEL of ± 8 kV for air and ± 6 kV for contact is appropriate for the majority of medical environments.

Subclause 36.202.2 b) 1

The requirement that the determination of compliance be based upon the application of individual electrostatic discharges ensures that the test is representative of actual use conditions. During testing, the application, to each test point, of multiple, repeated discharges (e.g. at approximately 1-s intervals) permits improved test statistics and allows the test to be completed quickly. However, for EQUIPMENT and/or SYSTEMS such as PATIENT monitors, the discharges could be misinterpreted as a PATIENT signal with a rate equal to the discharge repetition rate. Because it is highly unlikely that the EQUIPMENT and/or SYSTEM would be exposed to electrostatic discharges repeated at

such a rate in actual use, and to avoid penalizing such EQUIPMENT and/or SYSTEMS unnecessarily, the test results are evaluated based on considering the response of the EQUIPMENT and/or SYSTEM to each discharge individually.

Subclause 36.202.2 b) 2 and 3

ACCESSIBLE PART is a defined term in IEC 60601-1 that is used in this subclause to specify that discharges are applied only to points on the equipment enclosure that can be touched by the IEC test finger specified in IEC 60601-1 and to points internal to the enclosure that can be accessed without the use of an extra-corporeal device (TOOL). Non-accessible portions of ACCESSIBLE PARTS include female connector contacts and any other recessed connector contact that cannot be touched by the IEC test finger. Many connector ports are designed to handle high frequency information, either analogue or digital, and therefore cannot be provided with sufficient overvoltage protection devices.¹⁴ To ensure proper operation of the EQUIPMENT and/or SYSTEM, labelling is required, on the EQUIPMENT and/or SYSTEM and in the ACCOMPANYING DOCUMENTS, for connectors that are not tested for IMMUNITY to ESD.

Subclause 36.202.2 b) 4

Any electrical charge that has accumulated on internally-powered and/or CLASS II EQUIPMENT must be dissipated between each discharge of the ESD test generator so that the true effect of each discharge can be determined. Care must be taken in the discharge method used, to avoid over-testing the EQUIPMENT and/or SYSTEM. Hence, between discharges of the ESD generator, it is recommended to dissipate any accumulated charge on this kind of EQUIPMENT and/or SYSTEM through the specified resistor network. However, the resistor network should be disconnected and moved away during discharge of the ESD test generator, so that the test discharge and the resulting transient electric and magnetic fields are not affected.

Subclause 36.202.3 a) 1 and 2

It is expected that some PATIENT-COUPLED EQUIPMENT and/or SYSTEMS will use as a justification for a lower IMMUNITY COMPLIANCE LEVEL the fact that some physiological signals can be substantially below those induced by a field strength of 3 V/m.

The increased radiated RF IMMUNITY TEST LEVEL for LIFE-SUPPORTING EQUIPMENT and/or SYSTEMS is intended as an additional safety margin to decrease the likelihood that a portable communications device, such as a radio (cellular/cordless) telephone, could cause DEGRADATION of an EQUIPMENT and/or SYSTEM that results in harm to a PATIENT if the communications device is brought into PATIENT areas. This requirement is not intended to permit the use of such portable communications devices closer to EQUIPMENT and/or SYSTEMS. The safety margin for LIFE-SUPPORTING EQUIPMENT and/or SYSTEMS provided by the specified 10 V/m IMMUNITY TEST LEVEL in the frequency band 80 MHz to 2,5 GHz is particularly important because this band is used by hand-held

¹⁴ Excerpted from IEC 77B/261/CDV, draft amendment to IEC 61000-4-2.

and mobile two-way radios, digital portable telephones and digital mobile telephones. EQUIPMENT and/or SYSTEMS, particularly those which have not been tested in accordance with this standard, have been found to be more susceptible to transmissions from digital portable and mobile telephones than from older, analogue portable and mobile telephones of the same RATED maximum output power, and even more susceptible to transmissions from hand-held and mobile two-way radios, which often transmit with a higher output power than do portable and mobile telephones.

The frequency of 2,5 GHz was selected as the upper end of the test frequency range to cover the 2,40 to 2,50 GHz ISM band. Until the frequency range 2,5 GHz to 3,0 GHz is more heavily used, testing in this range will provide little additional benefit.

Subclause 36.202.3 a) 3

For EQUIPMENT and/or SYSTEMS specified for use only in a shielded location, it is appropriate to reduce the RF IMMUNITY TEST LEVEL by the minimum RF shielding effectiveness / filter attenuation specified for the shielded location by the manufacturer of the EQUIPMENT and/or SYSTEM. However, if it is necessary to specify use only in a shielded location as a result of the EMISSIONS characteristics of the EQUIPMENT and/or SYSTEM, a manufacturer could choose not to take advantage of this IMMUNITY testing allowance.

See Annex AAA, Subclause 6.8.201.1 c) 2.

For EQUIPMENT and/or SYSTEMS specified for use only in an enclosure that is well-shielded and well-filtered, the IMMUNITY TEST LEVEL may be reduced below a level produced by CISPR-compliant EMISSIONS; therefore, it is necessary to provide the user with instructions as to what restrictions are placed upon other devices used in this shielded location.

The frequency of 2,5 GHz was selected as the upper end of the test frequency range to cover the 2,40 to 2,50 GHz ISM band. Until the frequency range 2,5 GHz to 3,0 GHz is more heavily used, testing in this range will provide little additional benefit.

Subclause 36.202.3 a) 4

In medical practice, equipment is used that is tuned to a specific frequency in order to detect RF electromagnetic signals emanating from a PATIENT (e.g. MRI EQUIPMENT), or transmit data for remote monitoring of PATIENTS (e.g. telemetry). When an intentional receiver of RF electromagnetic energy is tuned to its frequency of reception, it is impossible for that section of the EQUIPMENT and/or SYSTEM to be immune to a test signal in its passband. Therefore, DEGRADATION of the receiving section is permitted. However, the other operational FUNCTIONS of the EQUIPMENT and/or SYSTEM must continue to operate as intended.

The frequency of 2,5 GHz was selected as the upper end of the test frequency range to cover the 2,40 to 2,50 GHz ISM band. Until the frequency range 2,5 GHz to 3,0 GHz is

more heavily used, testing in this range will provide little additional benefit.

Subclause 36.202.3 b) 3

The 2 Hz modulation frequency is a compromise that has been selected to be within physiological passbands and yet avoid the additional testing time that would result if every passband were tested. It is between the typical physiological passbands of respiratory and cardiology EQUIPMENT and/or SYSTEMS, and it corresponds to a secondary modulation frequency of some types of radio (cellular/cordless) telephones. The use of 1 kHz for EQUIPMENT and/or SYSTEMS that do not measure or control physiological parameters aligns with the requirements of IEC 61000-4-3. The PHYSIOLOGICAL SIMULATION FREQUENCY and the OPERATING FREQUENCY are required to be separated from the modulation frequency to make the identification of interference more obvious. Groups writing Particular (IEC 60601-2-X and ISO standards based on IEC 60601-1) Standards are encouraged to use the modulation frequency, PHYSIOLOGICAL SIMULATION FREQUENCY and OPERATING FREQUENCY requirements specified in this standard unless they are found to be inadequate for the specific product. For multi-parameter SYSTEMS, this will minimize the testing burden that would otherwise be imposed by the requirement to test over the entire frequency range at each different modulation frequency specified by the individual "part two" standard for each sub-SYSTEM.

Subclause 36.202.3 b) 4 and 5

The minimum dwell time requirement of 3 s for EQUIPMENT and/or SYSTEMS for which 2-Hz modulation is used is calculated from the maximum frequency sweep speed ($1,5 \times 10^{-3}$ decades/s) and maximum frequency step size (1 %) requirements of IEC 61000-4-3, with the result rounded to the nearest whole second. It assures that the EQUIPMENT and/or SYSTEM under test will be exposed to at least six cycles of the modulation. The minimum dwell time requirement of 1 s for all other EQUIPMENT and/or SYSTEMS is required so that performance DEGRADATION that might occur in response to the IMMUNITY TEST LEVEL can be observed by test engineers.

The use of adequate dwell time (or a correspondingly slow sweep rate) can be particularly important to IMMUNITY testing of EQUIPMENT and/or SYSTEMS. While interference with a video display unit can be perceived instantly, EQUIPMENT and/or SYSTEMS can have a very slow response time and may require a long dwell time in order to assess performance during the test. For example:

- A pulse oximeter may display a value averaged over several cardiac cycles.
- It may take several minutes to determine that the flow rate of an infusion pump has remained within an acceptable range.
- A ventilator may require several breath cycles to respond to a test signal.

NOTE Some slow sensors, e.g. chemical/biochemical sensors, may have response times of several

minutes but are not susceptible to RF fields. In such instances the response of the electronics, including filtering and/or averaging in hardware and/or software, would be the appropriate response time to consider in the determination of the dwell time.

Subclause 36.202.3 b) 8

Inclusion of the PATIENT may significantly affect the ELECTROMAGNETIC ENVIRONMENT of the EQUIPMENT and/or SYSTEM under test (the PATIENT may function as an antenna). For this reason, the development of adequate PATIENT models and test methodology will require extensive research for each type of PATIENT coupling. The requirement that the PATIENT coupling point does not have an intentional conductive and/or capacitive connection to ground during testing is to ensure that the PATIENT cable is tested in a worst-case condition. IEC 60601-1 treats the conditions in which the PATIENT is floating and in which the PATIENT is grounded as NORMAL CONDITIONS. Unintentional capacitance between the PATIENT coupling point and ground should be limited to a maximum of 250 pF. This is considered to be a worst case, ignoring the fact that the human body can act as an antenna that can significantly increase or decrease the amount of RF electromagnetic energy coupled into the EQUIPMENT and/or SYSTEM at a particular frequency, depending upon the physical configuration. SC 62A does not plan to develop an RF PATIENT model.

Subclause 36.202.3 b) 9

If operation of sub-SYSTEMS cannot be simulated, it is not practical to test LARGE, PERMANENTLY-INSTALLED EQUIPMENT and/or SYSTEMS for IMMUNITY to radiated RF fields in accordance with IEC 61000-4-3 on a test site. Therefore, they should be tested using communications equipment (legal use of transmitters) as RF test sources.

Subclause 36.202.4 a)

PATIENT cables are generally not long enough to run in parallel to mains cables for a sufficient distance to couple a DISTURBANCE that would justify the application of the capacitive coupling clamp test. Further, even in very long PATIENT cables, it is undesirable to arrange the cable near mains cables for electrical safety and noise reduction reasons. The requirement to have PATIENT cables attached will yield a realistic result of the effect on PATIENT cables in NORMAL USE of the electromagnetic phenomenon represented by the IMMUNITY TEST LEVEL.

While signal and interconnecting cables specified to be (i.e. restricted to) less than 3 m in length and all PATIENT-coupled cables are not tested directly, a failure of the EQUIPMENT and/or SYSTEM to meet the requirements of Subclause 36.202.1 j), *Compliance criteria*, even if it occurs due to coupling from cables that are tested directly to cables that are not tested directly, still constitutes failure of the EQUIPMENT and/or SYSTEM to meet the IMMUNITY requirements of this standard for this test.

Subclause 36.202.4 b) 3

The artificial hand application replicates the coupling path to ground through the PATIENT and is required to complete this coupling path during testing. Of the tests specified by this standard, use of the artificial hand is only appropriate for this test and for the IEC 61000-4-6 test because the artificial hand is not well-characterized for use with higher-frequency IMMUNITY tests.

Subclause 36.202.4 b) 3 third dash

For EQUIPMENT and/or SYSTEMS that have multiple PATIENT coupling points or multiple PATIENT-coupled parts, the specified combined impedance is intended to simulate the net RF coupling effect of the PATIENT to ground. If, for example, N artificial hands are conductively attached to N PATIENT coupling points, the combined impedance can be achieved with each artificial hand comprising $N \times 510 \Omega$ in series with $220/N$ pF. For PATIENT coupling points that have conductive contact with the PATIENT, another way to meet this requirement is to connect all PATIENT coupling points to a single artificial hand, provided normal operation is possible in this condition.

Subclause 36.202.4 b) 4

The artificial hand application replicates the coupling path to ground through the OPERATOR and is required to complete this coupling path during testing. Of the tests specified by this standard, use of the artificial hand is only appropriate for this test and for the IEC 61000-4-6 test because the artificial hand is not well-characterized for use with higher-frequency IMMUNITY tests.

Subclause 36.202.5 a)

While only power lines and a.c. inputs to a.c.-to-d.c. converters and battery chargers are tested directly, a failure of the EQUIPMENT and/or SYSTEM to meet the requirements of Subclause 36.202.1 j), *Compliance criteria*, even if it occurs due to coupling from power lines and a.c. inputs that are tested directly to cables that are not tested directly, still constitutes failure of the EQUIPMENT and/or SYSTEM to meet the IMMUNITY requirements of this standard for this test.

Subclause 36.202.5 b)

The combination wave test is performed with a 2Ω generator source impedance for the line(s) to line(s) test and a 12Ω generator source impedance for the line(s) to ground test.

Subclause 36.202.5 b) 3

The surge test is mainly a test for the ability of the power supply to withstand this high-energy pulse. If no surge protection device is installed in the EQUIPMENT and/or SYSTEM, a test at only the highest IMMUNITY TEST LEVEL specified in Subclause 36.202.5, *Surges*, ± 2 kV for a.c. power line(s) to ground and ± 1 kV for a.c. power

line(s) to line(s), will be the worst case. In that case, testing at lower IMMUNITY TEST LEVELS is not useful and would provide no additional information. If a surge protection device is installed in the EQUIPMENT and/or SYSTEM, testing at lower IMMUNITY TEST LEVELS is necessary to verify proper operation of the surge protection device.

Subclause 36.202.5 b) 4

CLASS II EQUIPMENT and/or SYSTEMS do not have a PROTECTIVE EARTH CONDUCTOR; therefore, application of the line(s) to ground surge is not possible with the standard coupling network. CLASS II EQUIPMENT and/or SYSTEMS are required to have a dielectric strength rating of 3 kV between mains and the ENCLOSURE for mains input voltages greater than 50 V and less than or equal to 150 V and a dielectric strength rating of 4 kV between mains and the ENCLOSURE for mains input voltages greater than 150 V and less than or equal to 250 V. In both cases, the required dielectric strength is greater than the surge IMMUNITY TEST LEVEL, so applying surges between line(s) and the ENCLOSURE would provide no additional information.

Subclause 36.202.6 a) 1

It is expected that some PATIENT-COUPLED EQUIPMENT and/or SYSTEMS will use as a justification for a lower IMMUNITY COMPLIANCE LEVEL the fact that some physiological signals can be substantially below those induced by the 3 V_{rms} IMMUNITY TEST LEVEL.

Subclause 36.202.6 a) 2

The increased conducted RF IMMUNITY TEST LEVEL in the ISM frequency bands between 150 kHz and 80 MHz for LIFE-SUPPORTING EQUIPMENT and/or SYSTEMS is intended as an additional safety margin to decrease the likelihood that a portable communications device, such as a two-way radio (walkie-talkie), could cause DEGRADATION of an EQUIPMENT and/or SYSTEM that results in harm to a PATIENT if the communications device is brought into PATIENT areas. This requirement is not intended to permit the use of such portable communications devices closer to EQUIPMENT and/or SYSTEMS. The safety margin for LIFE-SUPPORTING EQUIPMENT and/or SYSTEMS provided by the specified 10 V_{rms} IMMUNITY TEST LEVEL in the ISM frequency bands between 150 kHz and 80 MHz is particularly important because portable communications devices using these bands often have output power greater than 1 W.

Subclause 36.202.6 a) 3

For EQUIPMENT and/or SYSTEMS specified for use only in a shielded location, it is appropriate to reduce the RF IMMUNITY TEST LEVEL by the minimum RF shielding effectiveness / filter attenuation specified for the shielded location by the manufacturer of the EQUIPMENT and/or SYSTEM. However, if it is necessary to specify use only in a shielded location as a result of the EMISSIONS characteristics of the EQUIPMENT and/or SYSTEM, a manufacturer could choose not to take advantage of this IMMUNITY testing allowance.

See Annex AAA, Subclause 6.8.201.1 c) 2.

For EQUIPMENT and/or SYSTEMS specified for use only in an enclosure that is well-shielded and well-filtered, the COMPLIANCE LEVEL may be reduced below a level produced by CISPR-compliant EMISSIONS; therefore, it is necessary to provide the user with instructions as to what restrictions are placed upon other devices used in this shielded location.

Subclause 36.202.6 a) 4

In medical practice, equipment is used that is tuned to a specific frequency in order to detect RF electromagnetic signals emanating from a PATIENT (e.g. MRI EQUIPMENT). When an intentional receiver of RF electromagnetic energy is tuned to its frequency of reception, it is impossible for that section of the EQUIPMENT and/or SYSTEM to be immune to a test signal in its passband. Therefore, disturbance of the receiving section is permitted. However, the other operational FUNCTIONS of the EQUIPMENT and/or SYSTEM must continue to operate as intended.

Subclause 36.202.6 a) 5

Such EQUIPMENT and/or SYSTEMS are exempt from the requirements of Subclause 36.202.6, *Conducted disturbances, induced by RF fields*, because it is unlikely that RF energy in the frequency range 150 kHz to 80 MHz will be coupled into the EQUIPMENT and/or SYSTEM. Examples include some infra-red thermometers, infusion pumps, and defibrillators.

Subclause 36.202.6 b) 1 first dash

The interface characteristic impedance and associated injection parameters for EQUIPMENT and/or SYSTEMS vary more widely than for ITE devices, for which IEC 61000-4-6 was developed. This modification allows for more appropriate matching of the IMMUNITY stimulus to the EQUIPMENT and/or SYSTEM under test.

Subclause 36.202.6 b) 1 second dash

For EQUIPMENT and/or SYSTEMS, the requirements of IEC 61000-4-6 Subclause 6.2.2.1, *Coupling and decoupling networks for power supply lines*, are not compatible with the leakage current requirements of IEC 60601-1 and IEC 60601-1-1.

Subclause 36.202.6 b) 1 third dash, first dot

The tolerances for this calibration are modified in this standard to reflect the objective, exemplified in IEC 61000-4-3, that the inherent uncertainty of the test system does not result in under-testing of the EQUIPMENT and/or SYSTEM.

Subclause 36.202.6 b) 1 third dash, second dot

Calibration in a 150 Ω system reduces system uncertainty by harmonizing the characteristic impedance with that of the test environment, which is specified by IEC 61000-4-6 to be 150 Ω .

Subclause 36.202.6 b) 1 third dash, third dot

This modification is intended to clarify an unstated parameter within IEC 61000-4-6 by matching the maximum calibration step size to the maximum test step size. The effect is to avoid undetected variations in the characteristics of the calibration system that might distort the test results.

Subclause 36.202.6 b) 1 fourth dash

These modifications are intended to harmonize the IEC 61000-4-6 test environment with the prescribed safety environment of IEC 60601-1 for EQUIPMENT and/or SYSTEMS.

Subclause 36.202.6 b) 1 fifth dash

See Annex AAA, Subclause 36.202.6 b) 1 third dash, first dot.

Subclause 36.202.6 b) 1 sixth dash

For EQUIPMENT and/or SYSTEMS in which the system configuration can vary, an assumption of IMMUNITY of short interconnections (= 1 m) would not be appropriate.

Subclause 36.202.6 b) 3

EQUIPMENT and/or SYSTEMS will in general not tolerate the impedance that would be added to PATIENT cables by a CDN. Additionally, it is desirable to allow some RF signal to reach the PATIENT coupling point so that it can be determined whether demodulation or other coupling occurring at this point during the test affects the performance of the EQUIPMENT and/or SYSTEM. Termination as specified, to the ground reference plane of the PATIENT end of PATIENT-coupled cables, is necessary when using current clamp injection in order to complete the injection circuit, including the PATIENT coupling point. IEC 60601-1 treats the conditions in which the PATIENT is floating and in which the PATIENT is grounded as NORMAL CONDITIONS. The way the PATIENT cables have been treated is considered to be the worst case for this IMMUNITY test. These requirements should not be changed in Particular (IEC 60601-2-X and ISO standards based on IEC 60601-1) Standards.

See Annex AAA, Subclause 36.202.4 b) 3.

Of the tests specified by this standard, use of the artificial hand is only appropriate for this test and for the IEC 61000-4-4 test because the artificial hand is not well-

characterized for use with higher-frequency IMMUNITY tests.

Subclause 36.202.6 b) 3 third dash

See Annex AAA, Subclause 36.202.4 b) 3 third dash.

Subclause 36.202.6 b) 4

The artificial hand application replicates the coupling path to ground through the OPERATOR. If an EQUIPMENT and/or SYSTEM does not have PATIENT-coupled cables, the artificial hand simulating the capacitive coupling effect of the OPERATOR is required to complete the coupling path during testing.

Subclause 36.202.6 b) 5

This ensures that the equipotential ground is tested.

Subclause 36.202.6 b) 6

See Annex AAA, Subclause 36.202.3 b) 3.

For EQUIPMENT and/or SYSTEMS that control, monitor, or measure a physiological parameter, the IMMUNITY test signal applied to each cable should be modulated at 2 Hz, i.e. not just for the PATIENT-coupled cables. This ensures that the operation of the PATIENT FUNCTIONS are evaluated appropriately, even when testing power lines and interconnecting cables.

Subclause 36.202.6 b) 7 and 8

See Annex AAA, Subclause 36.202.3 b) 4 and 5.

Subclause 36.202.7 a)

The scope of IEC 61000-4-11 is limited to equipment with a RATED input current not exceeding 16 A per phase. However, this standard extends the application of IEC 61000-4-11 beyond 16 A per phase for LIFE-SUPPORTING EQUIPMENT and/or SYSTEMS because of the critical application. In addition, this standard applies the 5-s interruption test to all EQUIPMENT and/or SYSTEMS, along with an allowance for deviation from the requirements of Subclause 36.202.1 j), *Compliance criteria*, because the equipment necessary to perform this test is readily available.

For this test, "lower COMPLIANCE LEVELS" (see Subclause 36.202.1 a), *IEC 60601-1-2 TEST LEVELS*) means shorter duration of the voltage dip or interruption, and/or less of a dip in voltage.

Subclause 36.202.8

Additional magnetic field IMMUNITY requirements are under consideration.¹⁵

Subclause 36.202.8.1 a)

It is expected that video display terminals and other electron-beam devices (e.g. x-ray image intensifiers) will use a justification for lower IMMUNITY COMPLIANCE LEVELS as allowed by Subclause 36.202.1 a), IEC 60601-1-2 TEST LEVELS.

NOTE An IMMUNITY TEST LEVEL of 3,00 A/m is equivalent to a magnetic flux density of 3,78 μT (0,0378 Gauss) in free space.

Subclause 36.202.8.1 b) 1

Short-duration tests are not applicable to EQUIPMENT and/or SYSTEMS.

Subclause 36.202.8.2

This test is mainly applicable to products intended to be installed in electrical plants. The general hospital environment differs substantially from that influenced by high-voltage, high-power switchgear. Therefore, this test is not applicable.

Subclause 36.202.8.3

This test is mainly applicable to products intended to be installed in high-voltage substations. The general hospital environment differs substantially from that influenced by high-voltage, high-power switchgear. Therefore, this test is not applicable.

Subclause 36.202.9

This test is intended for very special equipment in large installations, of which mains and interconnecting cable length is at least approaching a quarter wavelength at 150 kHz. For 150 kHz, $\lambda/4 = 500$ m. Cables 500 m in length are generally not used in a hospital environment. Moreover, radio services in this frequency band are either short-range devices or maritime navigation systems. Therefore, no requirements apply.

Subclause 36.202.10

The ring wave and damped oscillatory wave tests are not applicable to EQUIPMENT and/or SYSTEMS because IMMUNITY to transients on power mains is already established sufficiently by the surge and burst tests. Comparing the power density spectra of ring waves and surges shows the severity of the ring wave (with the same voltage level) to be lower than that of the surge. In addition, power line filters commonly found in equipment to control EMISSIONS also impede frequencies around 100 kHz from entering equipment. In practice, equipment that passes the surge test also passes the

¹⁵ Under consideration by IEC TC 77 and IEC SC 62A.

ring wave test.

Subclause 36.202.11

This test is mainly applicable to products sensitive to the precise time of the zero crossing of the a.c. mains voltage. MEDICAL ELECTRICAL EQUIPMENT and/or SYSTEMS for use in the general hospital environment are, as a rule, not susceptible to small changes in the time of the zero crossing of the a.c. mains voltage. Therefore, no requirements apply.

Subclause 36.202.12

This standard is under development; therefore, no requirements apply.

Subclause 36.202.13

This standard is under development; therefore, no requirements apply.

Figure AAA201
Example of cable arrangement for radiated IMMUNITY test
(Only one orientation is shown)
(See Subclause 36.202.3 b) 8.)

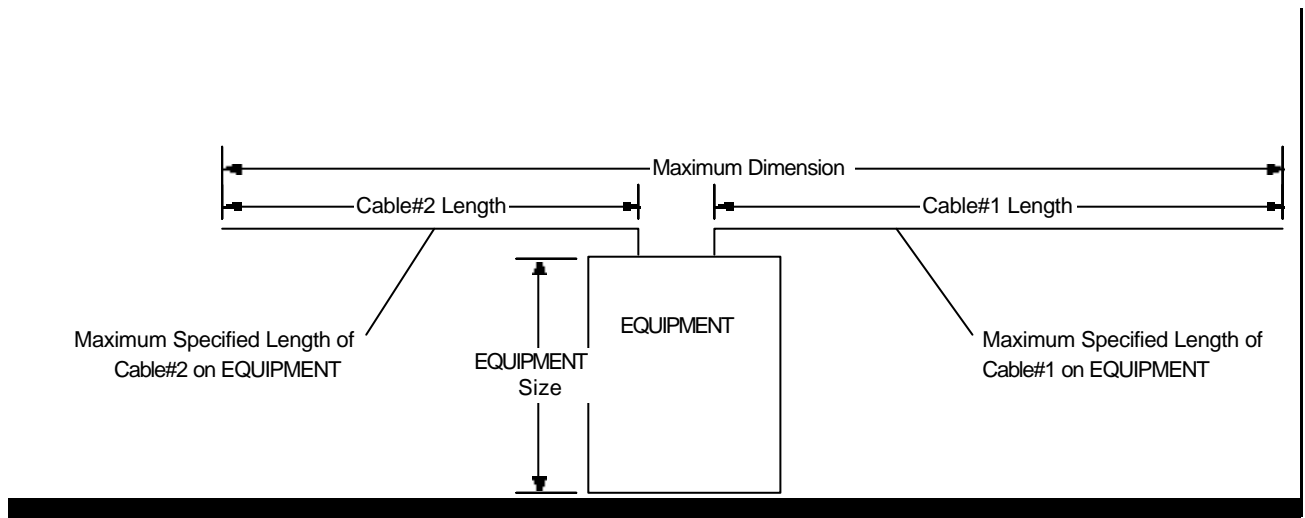
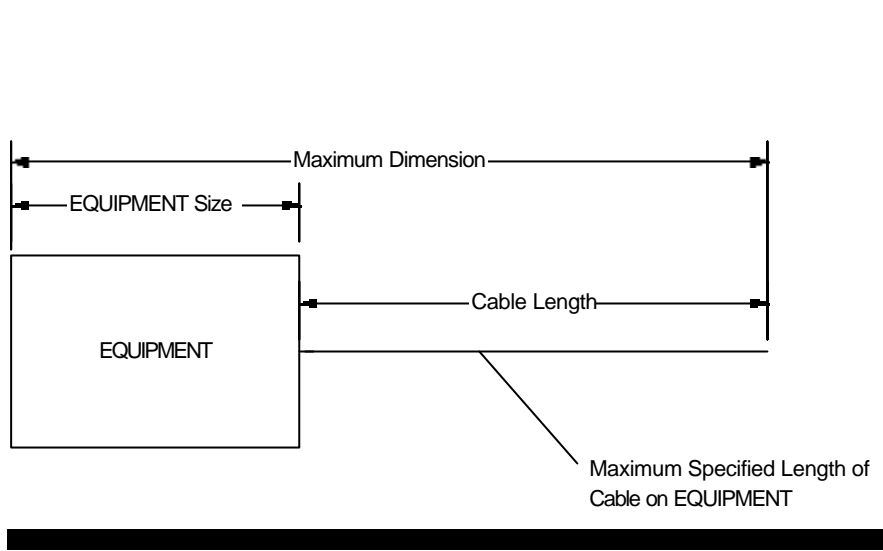

Figure AAA202
Examples showing maximum dimension for an EQUIPMENT
with one and with two cables

(See Subclauses 36.202.6 a) 5 and 6.)

Annex BBB
(informative)

**Example Completion of
Tables 201, 202, 203a, 203b, 204a, 204b, and 205a**

BBB1 Example completion of Table 201

This example is a hypothetical CISPR 11 Group 1 EQUIPMENT and/or SYSTEM that complies with Class B, IEC 61000-3-2 Class A, and IEC 61000-3-3. For the purpose of this example, the hypothetical EQUIPMENT and/or SYSTEM is a particular manufacturer's model 001.

Table 201 then appears as follows:

**Guidance and Manufacturer's Declaration
Electromagnetic Emissions
IEC 60601-1-2**

The Model 001 is suitable for use in the specified electromagnetic environment. The customer and/or the user of the Model 001 should assure that it is used in an electromagnetic environment as described below:		
Emissions Test	Compliance	Electromagnetic Environment Guidance
RF emissions CISPR 11	Group 1	The Model 001 uses RF energy only for its internal function. Therefore, its RF emissions are very low and are not likely to cause any interference in nearby electronic equipment.
RF emissions CISPR 11	Class B	The Model 001 is suitable for use in all establishments, including domestic establishments and those directly connected to the public low-voltage power supply network that supplies buildings used for domestic purposes.
Harmonic emissions IEC 61000-3-2	Class A	
Voltage fluctuations/ flicker emissions IEC 61000-3-3	Complies	

BBB2 Example completion of Table 201

This example is a hypothetical CISPR 11 Group 2 EQUIPMENT and/or SYSTEM that complies with Class A and for which IEC 61000-3-2 and IEC 61000-3-3 are not

applicable. For the purpose of this example, the hypothetical EQUIPMENT and/or SYSTEM is a particular manufacturer's Model 002.

Table 201 then appears as follows:

**Guidance and Manufacturer's Declaration
Electromagnetic Emissions
IEC 60601-1-2**

The Model 002 is suitable for use in the specified electromagnetic environment. The customer and/or the user of the Model 002 should assure that it is used in an electromagnetic environment as described below:		
Emissions Test	Compliance	Electromagnetic Environment Guidance
RF emissions CISPR 11	Group 2	The Model 002 must emit electromagnetic energy in order to perform its intended function. Nearby electronic equipment may be affected.
RF emissions CISPR 11	Class A	The Model 002 is suitable for use in all establishments other than domestic and those directly connected to the public low-voltage power supply network that supplies buildings used for domestic purposes.
Harmonic emissions IEC 61000-3-2	Not applicable	
Voltage fluctuations/ flicker emissions IEC 61000-3-3	Not applicable	

BBB3 Example completion of Table 202

This example is a hypothetical image intensifier that complies with all IEC 60601-1-2 TEST LEVELS except for the power frequency magnetic field IMMUNITY requirement. The power frequency magnetic field IMMUNITY of the example image intensifier is 0.3 A/m. For the purpose of this example, the hypothetical image intensifier is a particular manufacturer's Model 003.

Table 202 then appears as follows:

Guidance and Manufacturer's Declaration
Electromagnetic Immunity
IEC 60601-1-2

The Model 003 image intensifier is suitable for use in the specified electromagnetic environment. The customer and/or the user of the Model 003 image intensifier should assure that it is used in an electromagnetic environment as described below:			
Immunity Test	IEC 60601-1-2 Test Level	Compliance Level	Electromagnetic Environment Guidance
Electrostatic discharge (ESD) IEC 61000-4-2	± 6 kV contact ± 8 kV air	± 6 kV contact ± 8 kV air	Floors should be wood, concrete, or ceramic tile. If floors are covered with synthetic material, the relative humidity should be at least 30 %.
Electrical fast transient/burst IEC 61000-4-4	± 2 kV for power supply lines ± 1 kV for input/output lines	± 2 kV for power supply lines ± 1 kV for input/output lines	Mains power quality should be that of a typical commercial and/or hospital environment
Surge IEC 61000-4-5	± 1 kV differential mode ± 2 kV common mode	± 1 kV differential mode ± 2 kV common mode	Mains power quality should be that of a typical commercial and/or hospital environment.
Voltage dips, short interruptions and voltage variations on power supply input lines IEC 61000-4-11	< 5 % U_T (> 95 % dip in U_T) for 0,5 cycle 40 % U_T (60 % dip in U_T) for 5 cycles 70 % U_T (30 % dip in U_T) for 25 cycles < 5 % U_T (> 95 % dip in U_T) for 5 sec	< 5 % U_T (> 95 % dip in U_T) for 0.5 cycle 40 % U_T (60 % dip in U_T) for 5 cycles 70 % U_T (30 % dip in U_T) for 25 cycles < 5 % U_T (> 95 % dip in U_T) for 5 sec	Mains power quality should be that of a typical commercial and/or hospital environment. If the user of the Model 003 requires continued operation during power mains interruptions, it is recommended that the Model 003 image intensifier be powered from an uninterruptible power supply or a battery.
Power frequency (50/60 Hz) magnetic field IEC 61000-4-8	3 A/m	0.3 A/m	If image distortion occurs, it may be necessary to position the Model 003 image intensifier further from sources of power frequency magnetic fields or to install magnetic shielding. The power frequency magnetic field should be measured in the intended installation location to assure that it is sufficiently low.
NOTE U_T is the a.c. mains voltage prior to application of the test level.			

BBB4 Example completion of Tables 203a and 204a

This example is a hypothetical LIFE-SUPPORTING EQUIPMENT and/or SYSTEM. Thus, Tables 203a and 204a are used. For the purpose of this example, the hypothetical EQUIPMENT and/or SYSTEM is a particular manufacturer's Model 004. The Model 004 meets the IEC 60601-1-2 TEST LEVEL for the radiated IMMUNITY test but not for the conducted IMMUNITY tests. It is assumed that the justification for this is sufficient and is provided in the ACCOMPANYING DOCUMENTS. Because the claimed COMPLIANCE LEVELS must be an IMMUNITY TEST LEVEL of the basic EMC standard, the COMPLIANCE LEVELS are lower than the actual IMMUNITY LEVELS, as follows:

IMMUNITY Test	IEC 60601-1-2 TEST LEVEL	Actual IMMUNITY LEVEL	COMPLIANCE LEVEL
Conducted RF IEC 61000-4-6	3 Vrms 150 kHz to 80 MHz outside ISM bands	2 Vrms	1 Vrms
Conducted RF IEC 61000-4-6	10 Vrms 150 kHz to 80 MHz in ISM bands	2 Vrms	1 Vrms
Radiated RF IEC 61000-4-3	10 V/m 80 MHz to 2,5 GHz	13 V/m	10 V/m

Thus, $V_1 = 1$, $V_2 = 1$, and $E_1 = 10$. Calculating the expressions in square brackets in Tables 203a and 204a and rounding to two significant digits yields the following:

$$\frac{3,5m}{V_1} = 3,5 \quad \frac{3,5m}{V_2} = 3,5 \quad \frac{3,5}{E_1} = 1,2 \quad \frac{23}{E_2} = 7,7$$

These values are then used to complete Tables 203a and 204a as follows:

**Guidance and Manufacturer's Declaration
Electromagnetic Immunity
IEC 60601-1-2**

<p>The Model 004 is suitable for use in the specified electromagnetic environment. The customer and/or the user of the Model 004 should assure that it is used in an electromagnetic environment as described below:</p>			
Immunity Test	IEC 60601-1-2 Test Level	Compliance Level	Electromagnetic Environment Guidance
<p>Conducted RF IEC 61000-4-6</p> <p>Radiated RF IEC 61000-4-3</p>	<p>3 Vrms 150 kHz to 80 MHz outside ISM bands^a</p> <p>10 Vrms 150 kHz to 80 MHz in ISM bands^a</p> <p>10 V/m 80 MHz to 2,5 GHz</p>	<p>1 Vrms</p> <p>1 Vrms</p> <p>10 V/m</p>	<p>Portable and mobile RF communications equipment should be used no closer to any part of the Model 004, including cables, than the recommended separation distance calculated from the equation appropriate for the frequency of the transmitter.</p> <p align="center">Recommended Separation Distance</p> $d = 3,5\sqrt{P}$ $d = 12\sqrt{P}$ $d = 1,2\sqrt{P} \quad 80 \text{ MHz to } 800 \text{ MHz}$ $d = 7,7\sqrt{P} \quad 800 \text{ MHz to } 2,5 \text{ GHz}$ <p>where P is the maximum output power rating of the transmitter in watts (W) according to the transmitter manufacturer and d is the recommended separation distance in metres (m).^b</p> <p>Field strengths from fixed RF transmitters, as determined by an electromagnetic site survey,^c should be less than the compliance level in each frequency range.^d</p> <p>Interference may occur in the vicinity of equipment marked with the following symbol:</p> 

- ^a The ISM (industrial, scientific and medical) bands between 150 kHz and 80 MHz are 6,765 MHz to 6,795 MHz; 13,553 MHz to 13,567 MHz; 26,957 MHz to 27,283 MHz; and 40,66 MHz to 40,70 MHz.
- ^b The compliance levels in the ISM frequency bands between 150 kHz and 80 MHz and in the frequency range 80 MHz to 2,5 GHz are intended to decrease the likelihood that a portable communications device could cause interference if it is inadvertently brought into patient areas. For this reason, an additional factor of 10/3 is used in calculating the recommended separation distance for transmitters in these frequency ranges.
- ^c Field strengths from fixed transmitters, such as base stations for radio (cellular/cordless) telephones and land mobile radios, amateur radio, AM and FM radio broadcast, and TV broadcast cannot be predicted theoretically with accuracy. To assess the electromagnetic environment due to fixed RF transmitters, an electromagnetic site survey should be considered. If the measured field strength in the location in which the Model 004 is used exceeds the applicable RF compliance level above, the Model 004 should be observed to verify normal operation. If abnormal performance is observed, additional measures may be necessary, such as re-orienting or relocating the Model 004.
- ^d Over the frequency range 150 kHz to 80 MHz, field strengths should be less than 1 V/m.

NOTE These guidelines may not apply in all situations. Electromagnetic propagation is affected by absorption and reflection from structures, objects, and people.

**Recommended Separation Distances
between Portable and Mobile RF Communications Equipment
and the Model 004
IEC 60601-1-2**

Frequency of Transmitter Equation Rated Maximum Output Power of Transmitter watts	150 kHz to 80 MHz Outside ISM Bands $d = 3,5\sqrt{P}$ Separation Distance metres	150 kHz to 80 MHz In ISM Bands $d = 12\sqrt{P}$ Separation Distance metres	80 MHz to 800 MHz $d = 1,2\sqrt{P}$ Separation Distance metres	800 MHz to 2,5 GHz $d = 7,7\sqrt{P}$ Separation Distance metres
0.01	0,35	1,2	0,12	0,23
0.1	1,1	3,8	0,38	0,73
1	3,5	12	1,2	2,3
10	11	38	3,8	7,3
100	35	120	12	23
<p>For transmitters rated at a maximum output power not listed above, the separation distance can be estimated using the equation in the corresponding column, where P is the maximum output power rating of the transmitter in watts (W) according to the transmitter manufacturer.</p> <p>NOTE 1 The ISM (industrial, scientific and medical) bands between 150 kHz and 80 MHz are 6,765 MHz to 6,795 MHz; 13,553 MHz to 13,567 MHz; 26,957 MHz to 27,283 MHz; and 40,66 MHz to 40,70 MHz.</p> <p>NOTE 2 An additional factor of 10/3 is used in calculating the recommended separation distance for transmitters in the ISM frequency bands between 150 kHz and 80 MHz and in the frequency range 80 MHz to 2,5 GHz to decrease the likelihood that a portable communications device could cause interference if it is inadvertently brought into patient areas.</p> <p>NOTE 3 These guidelines may not apply in all situations. Electromagnetic propagation is affected by absorption and reflection from structures, objects, and people.</p>				

BBB5 Example completion of Tables 203b and 204b

This example is a hypothetical EQUIPMENT and/or SYSTEM that is not LIFE-SUPPORTING and that meets the IEC 60601-1-2 TEST LEVELS for the radiated and conducted IMMUNITY tests. Thus, Tables 203b and 204b are used. For the purpose of this example, the hypothetical EQUIPMENT and/or SYSTEM is a particular manufacturer's Model 005.

Using the IEC 60601-1-2 TEST LEVELS, $V_1 = 3$ and $E_1 = 3$. Calculating the expressions in square brackets in Table 203b and 204b and rounding to two significant digits yields the following:

$$\frac{3,5m}{V_1} = 1,2 \quad \frac{3,5}{E_1} = 1,2 \quad \frac{7}{E_2} = 2,3$$

These values are then used to complete Tables 203b and 204b as follows:

**Guidance and Manufacturer's Declaration
Electromagnetic Immunity
IEC 60601-1-2**

<p>The Model 005 is suitable for use in the specified electromagnetic environment. The customer and/or the user of the Model 005 should assure that it is used in an electromagnetic environment as described below:</p>			
Immunity Test	IEC 60601-1-2 Test Level	Compliance Level	Electromagnetic Environment Guidance
<p>Conducted RF IEC 61000-4-6</p> <p>Radiated RF IEC 61000-4-3</p>	<p>3 Vrms 150 kHz to 80 MHz</p> <p>3 V/m 80 MHz to 2,5 GHz</p>	<p>3 Vrms</p> <p>3 V/m</p>	<p>Portable and mobile RF communications equipment should be used no closer to any part of the Model 005, including cables, than the recommended separation distance calculated from the equation appropriate for the frequency of the transmitter.</p> <p align="center">Recommended Separation Distance</p> $d = 1,2\sqrt{P}$ $d = 1,2\sqrt{P}$ 80 MHz to 800 MHz $d = 2,3\sqrt{P}$ 800 MHz to 2,5 GHz <p>where P is the maximum output power rating of the transmitter in watts (W) according to the transmitter manufacturer and d is the recommended separation distance in metres (m).</p> <p>Field strengths from fixed RF transmitters, as determined by an electromagnetic site survey,^a should be less than the compliance level in each frequency range.^b</p> <p>Interference may occur in the vicinity of equipment marked with the following symbol:</p> 
<p>^a Field strengths from fixed transmitters, such as base stations for radio (cellular/cordless) telephones and land mobile radios, amateur radio, AM and FM radio broadcast, and TV broadcast cannot be predicted theoretically with accuracy. To assess the electromagnetic environment due to fixed RF transmitters, an electromagnetic site survey should be considered. If the measured field strength in the location in which the Model 005 is used exceeds the applicable RF compliance level above, the Model 005 should be observed to verify normal operation. If abnormal performance is observed, additional measures may be necessary, such as re-orienting or relocating the Model 005.</p> <p>^b Over the frequency range 150 kHz to 80 MHz, field strengths should be less than 3 V/m.</p> <p>NOTE These guidelines may not apply in all situations. Electromagnetic propagation is affected by absorption and reflection from structures, objects, and people.</p>			

**Recommended Separation Distances
between Portable and Mobile RF Communications Equipment
and the Model 005
IEC 60601-1-2**

Frequency of Transmitter Equation Rated Maximum Output Power of Transmitter watts	150 kHz to 80 MHz $d = 1,2\sqrt{P}$ Separation Distance metres	150 kHz to 800 MHz $d = 1,2\sqrt{P}$ Separation Distance metres	800 MHz to 2,5 GHz $d = 2,3\sqrt{P}$ Separation Distance metres
0.01	0,12	0,12	0,23
0.1	0,38	0,38	0,73
1	1,2	1,2	2,3
10	3,8	3,8	7,3
100	12	12	23

For transmitters rated at a maximum output power not listed above, the separation distance can be estimated using the equation in the corresponding column, where P is the maximum output power rating of the transmitter in watts (W) according to the transmitter manufacturer.

NOTE These guidelines may not apply in all situations. Electromagnetic propagation is affected by absorption and reflection from structures, objects, and people.

BBB6 Example completion of Table 205a

This example is a hypothetical EQUIPMENT and/or SYSTEM that is LIFE-SUPPORTING and that is specified for use only in a shielded location with a minimum RF shielding effectiveness / filter attenuation of 31 dB over the frequency range 150 kHz to 2,5 GHz. Thus, Table 205a is used. For the purpose of this example, the hypothetical EQUIPMENT and/or SYSTEM is a particular manufacturer's Model 006, and the required list of equipment that is allowed and/or prohibited inside the shielded location with the Model 006 is found on page 48 of the Service Manual.

The actual IMMUNITY LEVELS are below the lowest level listed in the basic EMC IMMUNITY standard; therefore, the COMPLIANCE LEVELS are equal to the actual IMMUNITY LEVELS, as follows:

IMMUNITY Test	IEC 60601-1-2 TEST LEVEL	Actual IMMUNITY LEVEL	COMPLIANCE LEVEL
Conducted RF IEC 61000-4-6	3 Vrms 150 kHz to 80 MHz outside ISM bands	0,3 Vrms	0,3 Vrms
Conducted RF IEC 61000-4-6	10 Vrms 150 kHz to 80 MHz in ISM bands	0,3 Vrms	0,3 Vrms
Radiated RF IEC 61000-4-3	10 V/m 800 MHz to 2,5 GHz	0,3 V/m	0,3 V/m

Thus, $V_1 = 0,3$, $V_2 = 0,3$, and $E_1 = 0,3$. These values are then used to complete Table 205a as follows:

**Guidance and Manufacturer’s Declaration
Electromagnetic Immunity
IEC 60601-1-2**

<p>The Model 006 is suitable for use in the specified electromagnetic environment. The customer and/or the user of the Model 006 should assure that it is used in an electromagnetic environment as described below:</p>			
Immunity Test	IEC 60601-1-2 Test Level	Compliance Level	Electromagnetic Environment Guidance
<p>Conducted RF IEC 61000-4-6</p>	<p>3 Vrms 150 kHz to 80 MHz outside ISM bands^a</p>	<p>0,3 Vrms</p>	<p>The Model 006 must be used only in a shielded location with a minimum RF shielding effectiveness and filter attenuation of 31 dB over the frequency range 150 kHz to 2,5 GHz. See page 48 of the Service Manual.</p> <p>Field strengths outside the shielded location from fixed RF transmitters, as determined by an electromagnetic site survey, should be less than 10 V/m.^b</p>
	<p>10 Vrms 150 kHz to 80 MHz in ISM bands^a</p>	<p>0,3 Vrms</p>	
<p>Radiated RF IEC 61000-4-3</p>	<p>10 V/m 80 MHz to 2,5 GHz</p>	<p>0,3 V/m</p>	<p>Interference may occur in the vicinity of equipment marked with the following symbol:</p> <div style="text-align: center;">  </div>
<p>^a The ISM (industrial, scientific and medical) bands between 150 kHz and 80 MHz are 6,765 MHz to 6,795 MHz; 13,553 MHz to 13,567 MHz; 26,957 MHz to 27,283 MHz; and 40,66 MHz to 40,70 MHz.</p> <p>^b Field strengths from fixed transmitters, such as base stations for radio (cellular/cordless) telephones and land mobile radios, amateur radio, AM and FM radio broadcast, and TV broadcast cannot be predicted theoretically with accuracy. To assess the electromagnetic environment due to fixed RF transmitters, an electromagnetic site survey should be considered. If the measured field strength outside the shielded location in which the Model 006 is used exceeds 10 V/m, observe the Model 006 to verify normal operation. If abnormal performance is observed, additional measures may be necessary, such as relocating the model 006 or using a shielded location with a higher RF shielding effectiveness and filter attenuation.</p> <p>NOTE 1 These guidelines may not apply in all situations. Electromagnetic propagation is affected by absorption and reflection from structures, objects, and people.</p> <p>NOTE 2 It is essential that the actual shielding effectiveness and filter attenuation of the shielded location be verified to assure that they meet the minimum specification.</p>			

Annex CCC (informative)

Guidance in Classification to CISPR 11

Rules for classification and separation into groups of equipment are contained in CISPR 11. The purpose of this annex is to provide additional guidance in the assignment of EQUIPMENT and/or SYSTEMS to the appropriate CISPR 11 group and class.

According to CISPR 11 Subclause 4.1, *Separation into groups*:

- *Group 1* contains all ISM equipment in which there is intentionally generated and/or used conductively coupled RF energy that is necessary for the internal functioning of the equipment itself.
- *Group 2* contains all ISM equipment in which RF energy is intentionally generated and/or used in the form of electromagnetic radiation for the treatment of material, and spark erosion equipment.

According to CISPR 11 Subclause 4.2, *Division into classes*:

- *Class A equipment* is equipment suitable for use in all establishments other than domestic and those directly connected to the public low-voltage power supply network that supplies buildings used for domestic purposes.

NOTE¹⁶ Although class A limits have been derived for industrial and commercial establishments, administrations may allow, with whatever additional measures are necessary, the installation and use of class A ISM equipment in a domestic establishment or in an establishment connected directly to domestic electricity power supplies.

- *Class B equipment* is equipment suitable for use in all establishments, including domestic establishments and those directly connected to the public low-voltage power supply network that supplies buildings used for domestic purposes.

Annex A of CISPR 11 gives examples for equipment classification and specifies "medical equipment" under Group 1 whereas "medical apparatus" can be found under Group 2, but only short wave and microwave therapy equipment is explicitly mentioned. No other type of medical EQUIPMENT and/or SYSTEM is mentioned.

CCC1 Separation into Groups

Most types of EQUIPMENT and/or SYSTEMS generate and/or use RF energy only for their internal function and therefore belong to Group 1.

¹⁶ Note 2 from CISPR 11 Subclause 4.2.

Examples of Group 1 EQUIPMENT and/or SYSTEMS are as follows:

- Electro- and magneto- cardiography EQUIPMENT and/or SYSTEMS
- Electro- and magneto- encephalography EQUIPMENT and/or SYSTEMS
- Electro- and magneto- myography EQUIPMENT and/or SYSTEMS

Group 1 also includes EQUIPMENT and/or SYSTEMS intended to deliver energy to the PATIENT, but in a form that is other than RF electromagnetic. Examples are as follows:

- Medical imaging EQUIPMENT and/or SYSTEMS:
 - diagnostic x-ray SYSTEMS for radiography and fluoroscopy (including cinefluoroscopy) for general purpose but also for special purposes, e.g. angiography, mammography, therapy planning, dentistry
 - computed tomography SYSTEMS
 - SYSTEMS for nuclear medicine
 - diagnostic ultrasound EQUIPMENT
- Therapy EQUIPMENT and/or SYSTEMS:
 - therapeutic x-ray SYSTEMS
 - dental EQUIPMENT
 - electron beam accelerators
 - ultrasound EQUIPMENT for therapy
 - EQUIPMENT for extracorporeal lithotripsy
 - infusion pumps
 - radiant warmers
 - infant incubators
 - ventilators
- Monitoring EQUIPMENT and/or SYSTEMS:
 - impedance plethysmography monitors

- pulse oximeters

Only a few EQUIPMENT and/or SYSTEMS apply RF energy to material (in this case to PATIENTS) and are therefore members of Group 2.

Examples are as follows:

- Medical imaging EQUIPMENT:
 - SYSTEMS for magnetic resonance imaging
- Therapy EQUIPMENT:
 - diathermy EQUIPMENT (short wave, ultra-short wave, microwave therapy EQUIPMENT)
 - hyperthermy EQUIPMENT

Additionally, high frequency surgical EQUIPMENT and/or SYSTEMS, when active, should be classified as Group 2 equipment (similar to spark erosion equipment), because they apply RF energy to the PATIENT.

CCC2 Division into Classes

EQUIPMENT and/or SYSTEMS predominantly intended for use in domestic environments and connected to the public low-voltage supply network (e.g. home care EQUIPMENT and EQUIPMENT for doctors offices in residential areas) should meet the requirements for CISPR 11 Class B.

EQUIPMENT and/or SYSTEMS that are intended to be (e.g. in hospitals) connected to dedicated supply systems (normally fed by separation transformers) should meet the requirements for either CISPR 11 Class A or Class B.

EQUIPMENT and/or SYSTEMS that are specified for use only in a shielded location may be classified based on compliance of the system formed by the EQUIPMENT and/or SYSTEM together with the specified type of shielded location, i.e. with the assumption that the EQUIPMENT and/or SYSTEM has been installed in a shielded location meeting the EQUIPMENT and/or SYSTEM manufacturer's specifications for minimum RF shielding effectiveness and minimum RF filter attenuation. If classification is made on this basis, Subclause 6.8.201.1 c) 2 of this standard requires a statement of this fact to appear in Table 201, as well as a recommendation to verify the actual shielding effectiveness and filter attenuation of the shielded location.

Annex DDD
(informative)**Guidance in the application of IEC 60601-1-2
to Particular Standards****DDD1 General**

This annex contains recommendations to standards committees writing EMC requirements for Particular Standards (IEC 60601-2-X (“Part two”) standards and ISO standards based on IEC 60601-1) to help ensure consistency in the application of IEC 60601-1-2. Such committees are encouraged to contact SC 62A with questions that arise in doing so.

This annex identifies the provisions of IEC 60601-1-2 that should be modified when this standard is applied to Particular Standards and provides guidance in doing so. It also identifies the provisions that should not be modified. In addition to this annex, the rationales in Annex AAA should be consulted for additional information and guidance in the application of this standard.

DDD2 Recommended modifications

Writers of Particular Standards are encouraged to make modifications or add additional information or clarification as follows:

- a) Delete the last sentence of Subclause 36.202.1 a), *IEC 60601-1-2 TEST LEVELS*. If the particular EQUIPMENT and/or SYSTEM cannot meet the IMMUNITY TEST LEVELS specified in Subclause 36.202, *IMMUNITY*, the Particular Standard should specify the minimum COMPLIANCE LEVEL allowed for each test and provide justification based upon physical, technological and/or physiological limitations. Once a lower IMMUNITY TEST LEVEL has been set and justified in a particular standard, the allowance for even lower COMPLIANCE LEVELS (the last sentence of Subclause 36.202.1 a), *IEC 60601-1-2 TEST LEVELS*) should then be explicitly disallowed by the Particular Standard.
- b) Make modifications to Subclauses 36.202.1 c), *Operating mode and configuration*; f), *Variable gain*; g), *PATIENT simulation*; and h), *Testing of normally non-observable CRITICAL FUNCTIONS*; to be more specific for the particular EQUIPMENT and/or SYSTEM, while maintaining the intent of this standard.
- c) Make modifications to or supplement Subclause 36.202.1 j), *Compliance criteria*, to provide specific performance criteria for the particular EQUIPMENT and/or SYSTEM that follow the intent of that subclause.
- d) If selection of one or two of the following four possibilities for the applicability of Tables 203a through 205b can be made for a Particular Standard, this may be

specified in Subclause 6.8.201.1, *ACCOMPANYING DOCUMENTS, General*.

- Tables 203a and 204a apply (i.e. the particular EQUIPMENT and/or SYSTEM is LIFE-SUPPORTING and not specified for use only in a shielded location)
 - Tables 203b and 204b apply (i.e. the particular EQUIPMENT and/or SYSTEM is not LIFE-SUPPORTING and not specified for use only in a shielded location)
 - Table 205a applies (i.e. the particular EQUIPMENT and/or SYSTEM is LIFE-SUPPORTING and is specified for use only in a shielded location)
 - Table 205b applies (i.e. the particular EQUIPMENT and/or SYSTEM is not LIFE-SUPPORTING and is specified for use only in a shielded location)
- e) The IMMUNITY TEST LEVELS in column 2 of Tables 202 through 205b may be modified as specified in DDD2 a) above, DDD4 below, and Subclause 6.8.201.1, *ACCOMPANYING DOCUMENTS, General*. If modifications are made to the IMMUNITY TEST LEVELS, the descriptions of the suitable ELECTROMAGNETIC ENVIRONMENT in column 4 should be modified accordingly.
- f) For LIFE-SUPPORTING EQUIPMENT and/or SYSTEMS for which an alarm is required in accordance with Subclause 36.202.7 a) 2; it is likely that the alarm will need to be powered by stored energy during power interruptions. To assure safety of the LIFE-SUPPORTING EQUIPMENT and/or SYSTEM, it may be necessary to add a requirement and a test to verify that sufficient stored energy is available to operate this alarm for an extended period of time, e.g. 5 minutes.

DDD3 Cautions

Writers of Particular Standards are cautioned against making other modifications, particularly those listed below:

- a) The Foreword, Introduction, Clause 1, *Scope and object*, and Clause 2, *Terminology and definitions*, should not be modified. Tables 201 and 202 should not be deleted. Other than the modifications described in DDD2 d) and e) above and DDD3 b) below, no other changes should be made to Tables 201 through 205b. Tables 201 through 205b provide the customer and/or user with essential information about the suitable electromagnetic use environment in a format common to all EQUIPMENT and/or SYSTEMS.
- b) Subclause 36.201, *EMISSIONS*, should not be modified, except for specification of Group 1 or 2 classification, using the guidance in Annex CCC, and classification to Class B, if the specific EQUIPMENT and/or SYSTEMS should only be classified as Class B. These changes may be indicated in Subclause 6.8.201.1 a) 3 and/or in Table 201. **Particular Standards are not free to modify the EMISSIONS requirements or test methods specified in CISPR 11 without the consent of**

CISPR Subcommittee B.

- c) Subclauses 36.202.3 b) 3 and 36.202.6 b) 6 should not be modified. The modulation frequencies chosen are adequate as is. If Particular Standards modify the modulation frequencies, additional testing would be required for SYSTEMS that use the product, as the SYSTEM would then need to be tested over the entire frequency range at each different modulation frequency specified in each applicable Particular Standard, as well as at the modulation frequency specified in this (general) Collateral Standard.
- d) Subclauses 36.202.3 b) 4 and 5 and 36.202.6 b) 7 and 8 should not be modified.
- e) Subclauses 36.202.1 e), *PATIENT-COUPLED EQUIPMENT and/or SYSTEMS*, 36.202.4 b) 3, and 36.202.6 b) 3 should not be modified. The PATIENT cables are treated differently in different tests. The default termination requirements specify that no intentional conductive or capacitive connection be made to ground because either the termination is not considered relevant (i.e. in the surge IMMUNITY test) or the prohibited termination is considered less stringent (i.e. in the ESD and radiated RF tests). In specific tests, the artificial hand from CISPR 16-1 has been specified because for these tests, it was either necessary for the artificial hand to be in place to properly perform the test or the use of the artificial hand was considered to be the worst case. IEC 60601-1 treats the conditions in which the PATIENT is floating and in which the PATIENT is grounded as NORMAL CONDITIONS. However, from a RF perspective, it is unlikely that a PATIENT in a medical environment would ever be as effectively grounded as in an EMC test environment in which a direct ground reference is used. As a result, the artificial hand specified in CISPR 16-1 is used to represent the grounded condition. The treatment of PATIENT cables in this standard has been chosen to represent a condition of use that is worst case for each IMMUNITY test.
- f) Subclause 36.202.3 b) 6 should not be modified. The introduction of metallic objects into the test area will distort the uniform field and increase testing uncertainty. The use of a metal plate to represent a PATIENT is discouraged.

DDD4 Additional recommendations

- a) If the expected electromagnetic characteristics of the intended use environment justify specification of higher IMMUNITY TEST LEVELS, the particular compliance criteria specified at the higher levels should follow the intent of Subclause 36.202.1 j), *Compliance criteria*, of this standard.
- b) If additional assurance of safety is needed, a second set of IMMUNITY TEST LEVELS may be specified for safety-based compliance criteria (e.g. specific types of safe failures allowed). Any safety-based criteria specified should supplement, rather than replace, particular compliance criteria that follow the intent of Subclause 36.202.1 j), *Compliance criteria*, of this standard. IMMUNITY TEST LEVELS

applicable to any safety-based compliance criteria should be significantly higher than those applicable to compliance criteria that follow the intent of Subclause 36.202.1 j) of this standard.

NOTE IEC 61000-1-2 (Methodology for the achievement of functional safety of electrical and electronic equipment) recommends setting, for safety-critical equipment, two sets of test levels and criteria: one for functional performance and another, at higher test levels, for safety. This edition of IEC 60601-1-2, while requiring that EQUIPMENT and/or SYSTEMS remain safe, specifies IMMUNITY TEST LEVELS and criteria for functional performance only.

- c) As an alternative to specifying safety-based criteria at a higher IMMUNITY TEST LEVEL, additional assurance of safety can be achieved by specifying particular compliance criteria, following the intent of Subclause 36.202.1 j), *Compliance criteria*, that shall be met at a higher IMMUNITY TEST LEVEL than the general test level specified in Subclause 36.202.1, *IMMUNITY, General*. This has the advantage that it reduces by half the amount of testing that would be required by performing a functional performance test at the general test level and then a safety test at a higher test level. However, similar to the recommendation in b) above, this higher IMMUNITY TEST LEVEL should be significantly higher than the IEC 60601-1-2 TEST LEVEL.

Annex EEE
(informative)

ELECTROMAGNETIC ENVIRONMENTS

Although Tables 202 through 205b are valid for a typical health care environment for EQUIPMENT and/or SYSTEMS, it would be useful to describe environments other than “typical health care” so that EQUIPMENT and/or SYSTEMS could be specified for use in these other environments.

Examples of ELECTROMAGNETIC ENVIRONMENTS are given below:

ELECTROMAGNETIC ENVIRONMENTS

Environment	Locations	General Characteristics
Typical Health Care	Hospital, large clinic, doctor's office	Partly controlled, covered by the general requirements of this standard
Residential	Doctor's office, small clinic	Not controlled, health care professional present
Residential	Home	Not controlled, health care professional not normally present
Transport Mobile	Car, aircraft (fixed wing and helicopter), ambulance	Not controlled, wide variations, critical receivers nearby, harsh environments for ESD, RF, electric and magnetic fields
Special	Operating theatre, emergency room	Case-by-case examination of environment.

Once sufficient information on the electromagnetic characteristics of a particular environment has been collected, specific IMMUNITY requirements may be proposed. However, there is not yet sufficient information to do so.

Annex FFF
(normative)**Normative references**

The following normative documents contain provisions that, through reference in this text, constitute provisions of this Collateral Standard. At the time of publication, the editions indicated were valid. All normative documents are subject to revision, and parties to agreements based on this Collateral Standard are encouraged to investigate the possibility of applying the most recent editions of the normative documents indicated below. Members of IEC and ISO maintain registers of currently valid International Standards.

- | | |
|--------------------------|---|
| IEC 60050(161) (1990-09) | International Electrotechnical Vocabulary
Chapter 161: Electromagnetic compatibility
Amendment 1 (1997-10)
Amendment 2 (1998-04) |
| IEC 60417-2 (1998-08) | Graphical symbols for use on equipment –
Part 2: Symbol originals |
| IEC 60601-1 (1988-12) | Medical electrical equipment
Part 1: General requirements for safety
Amendment 1 (1991-11)
Amendment 2 (1995-06)
Corrigendum (1995) |
| IEC 60601-1-1 (200x) | Medical electrical equipment
Part 1: General requirements for safety
1. Collateral standard: Safety requirements for medical
electrical systems
[Draft second edition, presently 62A/283/CDV] |
| IEC 60878 (1988-09) | Graphical symbols for electrical equipment in medical
practice |
| IEC 61000-3-2 (1998-04) | Electromagnetic compatibility (EMC)
Part 3: Limits
Section 2: Limits for harmonic current emissions
(equipment input current ≤ 16 A per phase) |
| IEC 61000-3-3 (1994-12) | Electromagnetic compatibility (EMC)
Part 3: Limits
Section 3: Limitation of voltage fluctuations and flicker in
low-voltage supply systems for equipment with rated |

current \leq 16 A

- IEC 61000-4-2 (1999-05) Electromagnetic compatibility (EMC)
Part 4: Testing and measurement techniques
Section 2: Electrostatic discharge immunity test
Basic EMC Publication
- IEC 61000-4-3 (1998-11) Electromagnetic compatibility (EMC)
Part 4: Testing and measurement techniques
Section 3: Radiated, radio-frequency, electromagnetic fields immunity test
Basic EMC Publication
- IEC 61000-4-4 (1995-01) Electromagnetic compatibility (EMC)
Part 4: Testing and measurement techniques
Section 4: Electrical fast transients/bursts immunity test
Basic EMC Publication
- IEC 61000-4-5 (1995-03) Electromagnetic compatibility (EMC)
Part 4: Testing and measurement techniques
Section 5: Surge immunity test
Basic EMC Publication
Corrigendum (1995)
- IEC 61000-4-6 (1996-04) Electromagnetic compatibility (EMC)
Part 4: Testing and measurement techniques
Section 6: Immunity to conducted disturbances, induced by radio-frequency fields
Basic EMC Publication
Corrigendum (1996)
- IEC 61000-4-8 (1993-06) Electromagnetic compatibility (EMC)
Part 4: Testing and measurement techniques
Section 8: Power frequency magnetic field immunity tests
Basic EMC Publication
- IEC 61000-4-11 (1994-06) Electromagnetic compatibility (EMC)
Part 4: Testing and measurement techniques
Section 11: Voltage dips, short interruptions and voltage variations immunity tests
- CISPR 11 (1997-12) Industrial, scientific and medical (ISM)
radio-frequency equipment -
Electromagnetic disturbance characteristics -
Limits and methods of measurement
Amendment 1 (1999-05)
Amendment 2 (XXXX)

CISPR 14-1 (1993-02)	Electromagnetic compatibility - Requirements for household appliances, electric tools and similar apparatus – Part 1: Emission - Product family standard Amendment 1 (1996-09) Amendment 2 (1998-12)
CISPR 15 (1999-04)	Limits and methods of measurement of radio disturbance characteristics of electrical lighting and similar equipment
CISPR 16-1 (1999-10)	Specification for radio disturbance and immunity measuring apparatus and methods Part 1: Radio disturbance and immunity measuring apparatus
CISPR 16-2 (1996-11)	Specification for radio disturbance and immunity measuring apparatus and methods Part 2: Methods of measurement of disturbances and immunity
CISPR 22 (1997-11)	Information technology equipment - Radio disturbance characteristics - Limits and methods of measurement
ISO 3744 (1994)	Acoustics - Determination of sound power levels of noise sources - Engineering methods for free-field conditions over a reflecting plane

Annex GGG
(informative)**Bibliography**

- IEC 60513 (1994-01) Fundamental aspects of safety standards for medical electrical equipment
- IEC 60601-1-4 (1996-05) Medical electrical equipment
Part 1: General requirements for safety
4. Collateral Standard: Programmable electrical medical systems
Amendment 1 (XXXX)
- IEC 61000-1-2 (199X) Electromagnetic compatibility (EMC)
Part 1: General
Section 2: Methodology for the achievement of the functional safety of electrical and electronic equipment
Basic EMC Publication
(Second edition currently IEC 77/197/CD)
- IEC 61000-2-5 (1995-09) Electromagnetic compatibility (EMC)
Part 2: Environment
Section 5: Classification of electromagnetic environments
Basic EMC Publication
- IEC 61000-3-4 (1998-10) Electromagnetic compatibility (EMC)
Part 3: Limits
Section 4: Limitation of emission of harmonic currents in low-voltage power supply systems for equipment with rated current greater than 16 A
- IEC 61000-3-5 (1994-12) Electromagnetic compatibility (EMC)
Part 3: Limits
Section 5: Limitations of voltage fluctuations and flicker in low-voltage power supply systems for equipment with rated current greater than 16 A
- IEC 61000-4-1 (199X) Electromagnetic compatibility (EMC)
Part 4: Testing and measurement techniques
Section 1: Overview of immunity tests
Basic EMC Publication
(Second edition currently 77/207/CDV)
- IEC 61000-5-1 (1996-12) Electromagnetic compatibility (EMC)
Part 5: Installation and Mitigation Guidelines

Section 1: General considerations

- IEC 61000-5-2 (1997-11) Electromagnetic compatibility (EMC)
Part 5: Installation and Mitigation Guidelines
Section 2: Earthing and Cabling
Technical Report, type 3
- IEC 61000-5-6 (199X) Electromagnetic compatibility (EMC)
Part 5: Installation and Mitigation Guidelines
Section 6: Mitigation of external influences
(Currently 77B/157/CD, August 1995)
- I-ETS 300 220 (1993-10) Radio Equipment and Systems (RES); Short Range
Devices (SRDs); Technical characteristics and test
methods for radio equipment to be used in the 25 MHz to
1 000 MHz frequency range with power levels ranging up
to 500 mW
- ISO 14971-1 (199X) Medical Devices - Risk Management -
Part 1: Application of Risk Analysis
(Currently ISO CD 14971, 210 N53)
- ITU Radio Regulations (1998) Volume 2 - Appendices